

# boards & solutions

# + ECE

Combined Print Magazine for the European Embedded Market

August 04/14

Cover Story

Fast and reliable solutions for everyday Test & Measurement tasks



  
**ROHDE & SCHWARZ**

**YELLOW PAGES 2014**  
The European Embedded Companies Directory



**FREE SHIPPING**  
ON ORDERS OVER €65\*



# HOW MANY SUPPLIERS DOES IT TAKE TO MAKE A MASTERPIECE?

**Authorized distributor for over 650 of the world's most trusted manufacturers.**

**FIND CONTACT AND ORDERING INFORMATION FOR YOUR REGION AT [DIGIKEY.COM/EUROPE](http://DIGIKEY.COM/EUROPE)**



**860,000+ PRODUCTS IN STOCK | 3 MILLION PARTS ONLINE | 100% AUTHORIZED DISTRIBUTOR**

\*A shipping charge of €18.00 (£12.00) will be billed on all orders of less than €65.00 (£50.00). All orders are shipped via UPS for delivery within 1-3 days (dependent on final destination). No handling fees. All prices are in euro and British pound sterling. If excessive weight or unique circumstances require deviation from this charge, customers will be contacted prior to shipping order. Digi-Key is an authorized distributor for all supplier partners. New product added daily. © 2014 Digi-Key Corporation, 701 Brooks Ave. South, Thief River Falls, MN 56701, USA





## Dear Readers,



As you all know the August issue of *Boards & Solutions* and *ECE*, the combined print magazine for the European Embedded Market, always features the

### Yellow Pages 2014 - The Embedded Companies Directory

This year's edition of our Embedded Companies Directory is split into 2 sections. The first part provides you with more than 100 short company profiles, including a QR code which leads you to the full company profile (including overview about

products & services, contact information, product news,... ) on the [embedded-control-europe.com](http://embedded-control-europe.com) portal. The second part of the Yellow Pages is a reference list showing in which product categories the companies are active.

But beside the Yellow Pages 2014 this issue, contains much more information about actual trends in this market place. Despite the fact that simulation plays a more and more important role in the design of embedded systems – at the end you have to measure whether the final design behave like it should. But what instrument is the best for fast and reliable test & measurement tasks? There is a multitude of various test & measurement instruments in the embedded market but our cover story shows that the “good old” oscilloscope as an universal instrument is still alive. But nowadays it contains much more functionality and touch screen operation makes it – despite its complexity – easy to use. The R&S RTE described in the cover story include many integrated measurement tools for detailed signal analysis. They range from simple cursor functions to mask tests to complex mathematical operations. Many measurement functions such as histograms, spectrum display and mask tests are hardware-implemented. This ensures a very responsive scope and a high acquisition rate. And statistically conclusive measurement results are available fast. In addition to the automatic measurements that are customary for digital oscilloscopes, the oscilloscope offers the QuickMeas function, which simultaneously displays the results of several measurement functions, which users select according to their needs. Mask tests reveal whether a specific signal lies within defined tolerance limits and use statistical pass/fail evaluation to assess the quality and stability of a device under test. The FFT function of the oscilloscope makes spectral analysis easy. The high acquisition and post processing rate conveys the impression of a live spectrum, and operation is as simple as entering the centre frequency, span and resolution bandwidth. And this list continues. Another article describes how to measure the energy consumption in embedded systems.

But we did also not forget to inform you about the actual hot topics in the embedded market – wearable devices and the Internet of Things. You'll find articles containing information about these trends. Enjoy reading!

*Yours Sincerely*  
 Wolfgang Patelay  
 Editor



Focussing on  
your solution

## COM Express™ Type 6 and Type 2

New Intel® Atom™ Technology

MSC is offering Intel's latest Atom™ generation on different platforms. Besides Qseven® and COM Express™ Type 6, now a COM Express™ Type 2 module brings legacy interfaces for your existing embedded systems. Starter kits, carrier boards and sophisticated cooling solutions shorten your time-to-market.

MSC C6C-BT (Type 6)

MSC CXC-BT (Type 2)



**COM Express**

- Intel® Atom™ E38xx, Celeron® J1900, N2930
- Intel® Gen. 7 HD graphics
- Up to 8GB DDR3L
- MicroSD card socket
- Various display interfaces
- Extended temperature
- 95 mm x 95 mm

+49 7249 910-0 | [info@msc-technologies.eu](mailto:info@msc-technologies.eu)

[www.msc-technologies.eu](http://www.msc-technologies.eu)



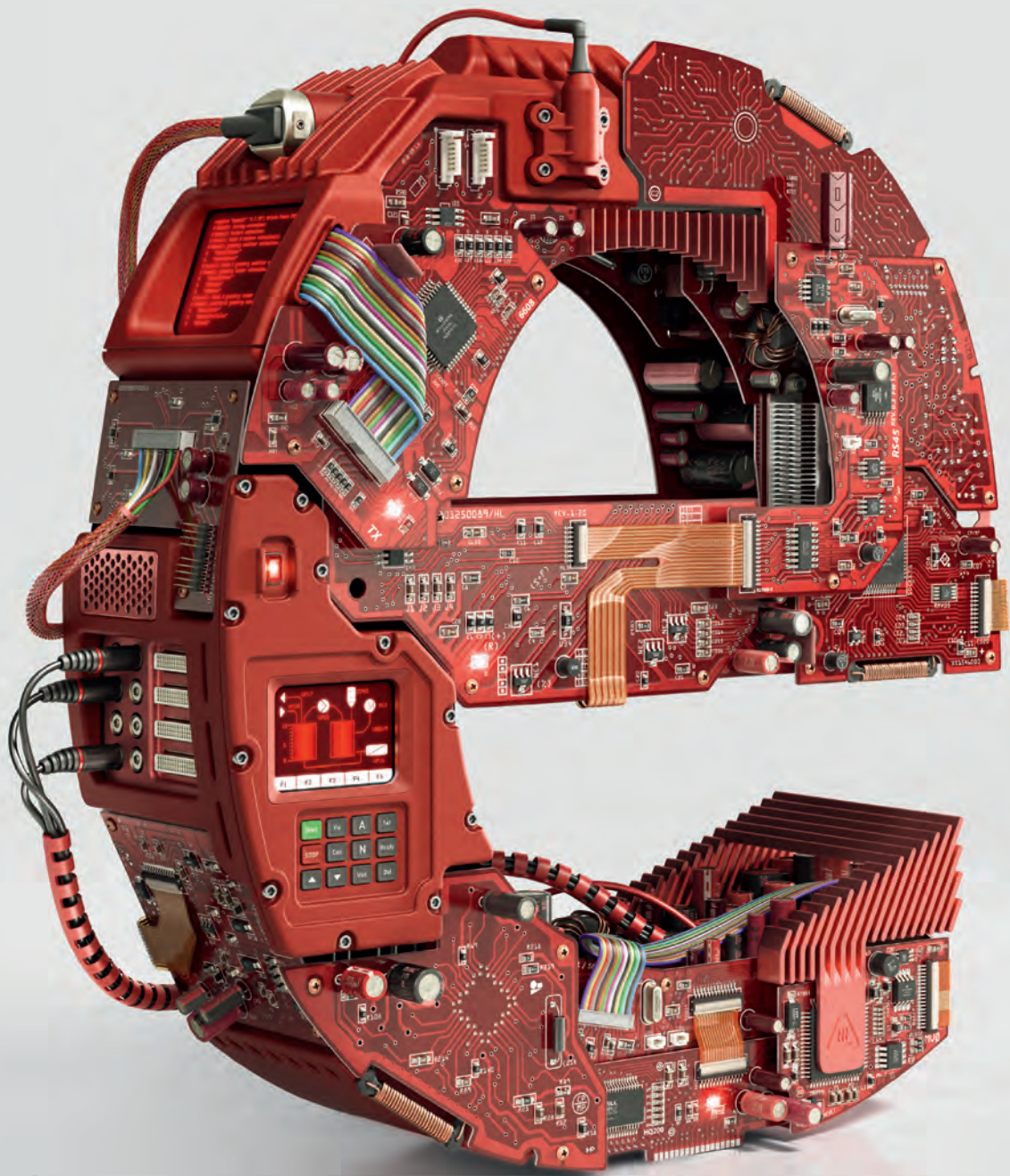

26th International Trade Fair for Electronic  
Components, Systems and Applications  
Messe München, November 11–14, 2014  
[www.electronica.de](http://www.electronica.de)

50 years  
electronica



Messe München  
International

Connecting Global Competence

# Welcome to Planet e.

The entire embedded universe at a single location!

Tickets & Registration

[www.electronica.de/en/tickets](http://www.electronica.de/en/tickets)



**electronica** 2014

inside tomorrow



<b>Viewpoint</b>	<b>3</b>
<b>Test &amp; Measurement</b>	
Fast and reliable solutions for everyday Test & Measurement tasks	6
Measuring energy consumption in embedded systems	10
<b>Internet-of-Things</b>	
Wearable devices and the Internet of Things	12
<b>Embedded Computing</b>	
A new era of modular application-ready systems	14
COM Express Type 6 module family with latest Intel Atom technology	18
SyncE, IEEE1588, and GPS receiver options extend MicroTCA applications	20
<b>Transportation</b>	
Public transport revolution by contactless ticketing system	23
<b>Power Supplies</b>	
SMPS: a crucial component of systems providing Internet services	25
<b>Yellow Pages</b>	<b>29</b>
<b>Product News</b>	<b>47</b>

**Fast and reliable solutions for everyday Test & Measurement tasks 6**



The R&S RTE digital oscilloscopes from Rohde & Schwarz feature a sampling rate of 5 GS/s, an acquisition rate of one million waveforms per second and good signal fidelity. A comprehensive set of measurement and analysis tools delivers fast results, and the high-resolution touchscreen makes the R&S RTE easy to use.

**Wearable devices and the Internet of Things 12**

Wearable devices are a hot topic these days, as illustrated by the new \$5,000 "Make it Wearable" challenge recently issued by Intel. This challenge will reward both visionaries and builders who conceive of or construct wearable applications that can shift personal computing into new innovative directions.

**A new era of modular application-ready systems 14**



This article describes how the MEN approach to turn-key systems is emerging in the shape of a modular concept for different formats.

**SMPS: a crucial component of systems providing Internet services 25**



The growth of the Internet infrastructure, along with the rising cost of energy and environmental concerns, makes SMPS efficiency optimization across the entire load range a key requirement. This challenging task is combined with the need for higher power densities, which can be achieved only by future significant progress in SMPS technology.

**Yellow Pages 2014 The Embedded Companies Directory 29**



This year's edition of our Embedded Companies Directory is split into 2 sections. The first part provides you with more than 100 short company profiles, including a QR code which leads you to the full company profile (including overview about products & services, contact information, product news,...) on the embedded-control-europe.com portal. The second part of the Yellow Pages is a reference list showing in which product categories the companies are active.

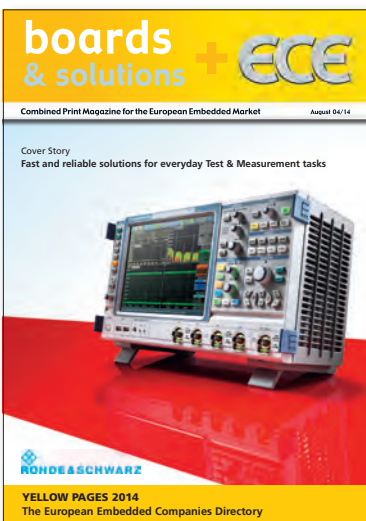

Cover Photo: Rohde & Schwarz





**SAFE**  
**RELIABLE**  
**SECURE**

## TRUSTED SOFTWARE FOR EMBEDDED DEVICES

For more than 30 years the world's leading companies have trusted **Green Hills Software's** secure and reliable high performance software for safety and security critical applications.

From avionics and automotive, through telecoms and medical, to industrial and smart energy, Green Hills Software has been delivering proven and secure underpinning technology.

To find out how the world's most secure and reliable operating systems and development software can take the risk out of your next project, visit [www.ghs.com/s4e](http://www.ghs.com/s4e)



**Green Hills®**  
SOFTWARE

Copyright © 2014 Green Hills Software. Green Hills Software and the Green Hills logo are registered trademarks of Green Hills Software. All other product names are trademarks of their respective holders.



# Fast and reliable solutions for everyday Test & Measurement tasks

*The R&S RTE digital oscilloscopes from Rohde & Schwarz feature a sampling rate of 5 GS/s, an acquisition rate of one million waveforms per second and good signal fidelity. A comprehensive set of measurement and analysis tools delivers fast results, and the high-resolution touchscreen makes the R&S RTE easy to use.*



■ The main purpose of a digital oscilloscope is to measure electrical signals. This can be simple measurement of signal characteristics such as frequency and rise and fall times or complex analysis such as determining the switching loss of a switched-mode power supply. The most important factor for users is that they can rely on the quality of measurement results. Rohde & Schwarz has many years of experience in the development of precision test and measurement equipment, which also benefits the R&S RTE oscilloscope.

The more details an oscilloscope can show, the higher the probability that the user will be able to analyze signal faults or important events. As a prerequisite, the oscilloscope must have a high time resolution that is based on the sampling rate. In addition, many applications also require long record lengths, for instance for analyzing the data content of serial protocols. In order to maintain a high sampling rate even for long signal sequences, the oscilloscope requires a deep memory. The R&S RTE offers a powerful combination of sampling rate and memory depth. A sampling rate of 5 Gsample/s at a memory depth of 10 Msample is available per channel (can be optionally expanded to 50 Msample per channel). The less often signal faults occur, the longer it can take to detect them. This makes a high acquisition rate critical. The core of the R&S RTE is an ASIC that was especially designed for parallel processing. As a result, the oscilloscope can acquire, analyze and display more than

one million waveforms per second without a special acquisition mode. The high acquisition rate makes it possible to find signal faults faster and more reliably, effectively shortening debugging time.

The highly accurate digital trigger system from Rohde & Schwarz provides precise results. This unique system determines when a trigger condition is met by directly analyzing the digitized signal with 500 fs resolution independently of the current sampling rate. The result is very low trigger jitter (< 1ps RMS) and high measurement accuracy. Thanks to the digital trigger system, the trigger hysteresis can be adjusted to the signal quality. This ensures, for example, stable triggering even on extremely noisy signals. The single-core A/D converter with more than seven effective bits (ENOB) almost completely eliminates signal distortion. The input sensitivity of 1 mV/div without any bandwidth limitations ensures that low-amplitude signals can also be measured with a high degree of accuracy.

The R&S RTE includes many integrated measurement tools for detailed signal analysis. They range from simple cursor functions to mask tests to complex mathematical operations. Many measurement functions such as histograms, spectrum display and mask tests are hardware-implemented. This ensures a very responsive scope and a high acquisition rate. And statistically conclusive measurement results are available fast. In addition to

the automatic measurements that are customary for digital oscilloscopes, the oscilloscope offers the QuickMeas function, which is unique for an instrument in this class. QuickMeas simultaneously displays the results of several measurement functions, which users select according to their needs. A toolbar at the upper edge of the screen provides fast access to this function.

Mask tests reveal whether a specific signal lies within defined tolerance limits and use statistical pass/fail evaluation to assess the quality and stability of a device under test. Mask creation in the R&S RTE is simply a matter of pressing a few buttons. The high acquisition rate ensures that mask violations are detected rapidly and reliably. Signal anomalies and unexpected results are easy to identify by stopping the measurement if the mask is violated. Where does the interference pulse in the signal come from? What caused the loss of a data bit? The real cause of a problem can often only be found by looking at the history of a signal sequence. The R&S RTE history function always provides access to previously acquired waveforms. This enables users to later analyze in detail the measurement data stored in memory.

The FFT function of the oscilloscope makes spectral analysis easy. The high acquisition and postprocessing rate conveys the impression of a live spectrum, and operation is as simple as entering the center frequency, span



# Control Your Remote Devices with IoT Cloud Services

**SEMA Cloud** for Remote Device Management, Control, and Configuration



## Device Monitoring and Control

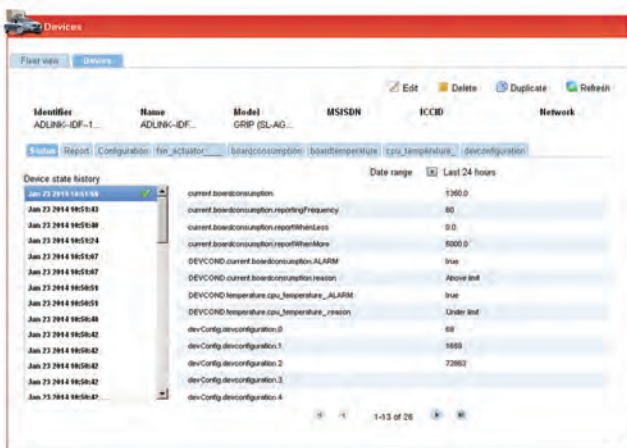

- System status monitoring
- Secure remote access and device control

## Analytics and Alert Management

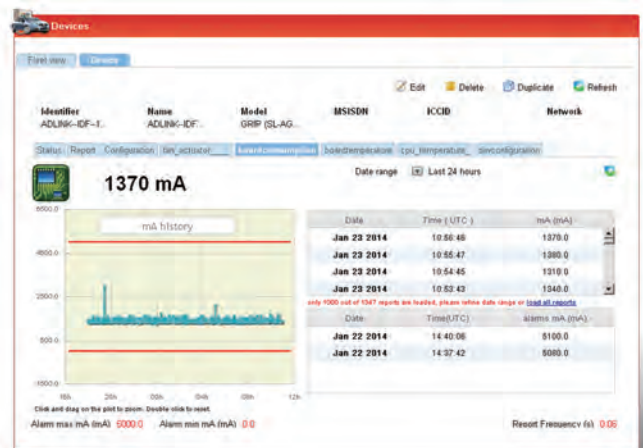

- Policy-setting for multiple parameters
- Alert management and configuration





Figure 1. The R&S RTE is available with two or four channels and a bandwidth of 200 MHz, 350 MHz, 500 MHz or 1 GHz.



Figure 2. Rare signal faults are found quickly thanks to the high acquisition rate of one million waveforms per second.

and resolution bandwidth. Using the persistence mode, rapid signal changes, sporadic signal interference and weak superimposed signals can easily be made visible. The ability to overlap FFT frames enables the oscilloscope to detect intermittent signals such as pulsed interferers. This powerful FFT function plus the high dynamic range and input sensitivity of 1 mV/div make the R&S RTE ideal for tasks such as EMI debugging of electronic circuits during product development.



Figure 3. Together with the R&S RTE HZ-15 near-field probe set, the R&S RTE oscilloscope with its powerful FFT function is ideal for EMI debugging during development.

Thanks to the high-resolution 10.4" XGA touchscreen, users can intuitively perform their daily T&M tasks. For example, users can simply "drag & drop" waveforms to arrange them on the screen. The screen can flexibly be divided into several diagrams according to the user's requirements. Realtime miniature views of the signals on the edge of the screen allow users to always see what is happening. The R&S RTE controls are color-coded and indicate which channel is currently active. The color coding corresponds to the signal display on the screen. Dialog boxes are opened as semi-transparent overlays over the active waveforms, which maintain their full size.

Users can adjust the transparency of dialog boxes as required. Signal flow diagrams and forward and back buttons in the dialog boxes simplify navigation. The configurable toolbar provides fast access to frequently used functions. Users simply select a tool and apply it to their waveform. Tools that have a similar function are grouped together. In addition to the standard tool suite, the R&S RTE features many highlights such as fingertip zoom,

which allows users to quickly view signal details by moving their finger or mouse along the signal. Another example is the SaveSet tool which enables users to quickly load different configurations. To select the right configuration, the user simply swipes a screenshot.

In addition to the standard functionality, the oscilloscope offers various optional application solutions, including trigger and decoding options for serial buses (such as I2C, SPI and CAN) and a power analysis option. The logic analysis capability offered by the R&S RTE is essential for analyzing digital components of embedded designs. The R&S RTE-B1 mixed signal option can be added to any base unit and offers 16 additional digital channels with a sampling rate of 5 Gsample/s and a memory depth of 100 Msample per channel. It is possible to decode up to four serial or parallel buses simultaneously.

A comprehensive portfolio of high-quality active and passive probes is available for the R&S RTE to perform measurements in common voltage and current ranges. One of the highlights of the active probes from Rohde & Schwarz is a micro button on the probe tip. This button can be used to perform a variety of functions such as run/stop, autoset and adjust offset on the oscilloscope. The highly precise R&S ProbeMeter DC voltmeter (measurement error:  $\pm 0.1\%$ ) is integrated into the active probe and provides a convenient means of answering questions such as "Is the supply voltage correct?" and "Is DC voltage superimposed?" ■



## Product News

### ■ Digi-Key and Mentor: web-based professional EDA software

Digi-Key has collaborated with Mentor Graphics to create a unique concept-to-prototype design tool targeted for green-field projects before transition to production. Available from Digi-Key, the Designer Schematic product from Mentor Graphics addresses escalating demand from professional engineers for Electronic Design Automation software at an affordable price.

[News ID 1606](#)

### ■ LynxWorks changes company name to Lynx Software Technologies

LynxWorks announces its new name: Lynx Software Technologies. Over its 25 year history, the company's products have been

used in successive generations of embedded devices, always providing fail-safe reliability with the highest levels of performance. They continue to be baseline solutions to developers building aerospace and defense, avionics, medical, industrial, consumer, office automation, transportation, and security applications and devices.

[News ID 1592](#)

### ■ Lauterbach: TRACE32 tool qualification support-kit for code coverage

Lauterbach has announced a Tool Qualification Support-Kit for the TRACE32 code coverage analysis. This qualification toolkit was designed to help customers facing the many challenges of software development for safety-related systems to complement the tool qualification when

TRACE32 is selected as preferred solution for trace-based code coverage analysis. It aims to meet the requirements for the development of avionic and automotive applications in compliance with DO-178C and ISO 26262.

[News ID 1756](#)

### ■ Imagination: FlowCloud to enable IoT development on MIPS development boards

Imagination is making its FlowCloud technology available to developers, including the maker community, hobbyists and students, to speed application development for the Internet of Things. FlowCloud support will be available on several low-cost development boards with MIPS CPUs across a range of operating systems.

[News ID 1608](#)



#### ■ iSYSTEM: efficiently migrate from single- to multi-core embedded systems

iSYSTEM and Timing-Architects Embedded Systems are announcing the availability of a tool chain that enables continuous and automated software development of multi-core embedded systems. The cooperation of the two companies provides the answer to the question of how to efficiently and without risk migrate from single- to multi-core embedded systems.

[News ID 1773](#)

#### ■ Adeneo: Windows Embedded Compact support for TI's Sitara AM437x processors

Adeneo Embedded announced the ongoing development of Windows Embedded Compact 7 BSP solution for the Sitara AM437x processor platform from Texas Instruments. Adeneo will be the first to provide a Windows Embedded Compact 7 solution on AM437x processors. The WEC7 BSP will support the latest AM437x EVM development kit from TI.

[News ID 1763](#)

#### ■ Rohde & Schwarz: HAMEG products now integral part of portfolio

T&M products from Rohde & Schwarz subsidiary HAMEG Instruments will now be marketed under the Rohde & Schwarz logo – starting in June with two new instruments. The company HAMEG Instruments will continue to operate as an independent company under the umbrella of the Rohde & Schwarz group of companies. The two sites in Mainhausen and Chemnitz will be expanded.

[News ID 1761](#)

#### ■ PragmaDev: model based testing feature in latest release

PragmaDev RTDS latest release V4.5 introduces 35 new features making it the most complete model driven development and testing tool dedicated to event driven systems. Real Time Developer Studio offers three levels of modeling and testing: informal, semi-formal, and fully formal.

[News ID 1578](#)

#### ■ Rutronik: registration-free access to e-commerce platform

As of now, interested parties can also use the Rutronik24 e-commerce platform without registration. This will only become necessary when an order is placed. This registration-free access now also gives new customers the opportunity to view the entire Rutronik24 product range comprising more than one million items from all product areas.

[News ID 1644](#)

#### ■ Altium and In-Circuit Design to provide new extensions for Designer tool

Altium in cooperation with Australian based In-Circuit Design announce the availability of new extensions for Altium Designer for advanced stackup planning and power distribution network analysis to bring comprehensive high-speed design capabilities to the mainstream market, at an affordable price.

[News ID 1757](#)

#### ■ Lauterbach and Evidence collaborate on OSEK/VDX tool chain

Lauterbach and Evidence announce a partnership, where Lauterbach's TRACE32 debugger supports seamlessly Evidence' ERIKA Enterprise, the first open source, royalty free, OSEK/VDX certified RTOS. ERIKA Enterprise and its companion RT-Druid is a complete open source, royalty free development environment for OSEK/VDX compliant systems. Based on Eclipse, it works with OSEK-OIL files and several compilers on several architectures, with GCC being "built in". When building the ECU application, RT-Druid also generates several support files for the debugger.

[News ID 1654](#)

#### ■ IS2T: MicroEJ 3.0 application platform for resource-constrained microprocessors

IS2T announced the latest version of the MicroEJ SDK to prototype, design, develop, and test applications before deployment to smart embedded devices. With MicroEJ 3.0, IS2T now engages into the promising Internet of Things market by offering a standard solution for managing multiple connected applications. MicroEJ can turn a simple hardware platform into a rich services platform, enabling suppliers to deploy several independent or cooperative applications onto the same embedded device and add extended after-sales features to meet customer demand.

[News ID 1774](#)

#### ■ Verocel: advanced life-cycle and verification management environment

Verocel announces the first full commercial release of VeroTrace, an advanced life-cycle management environment that has been used to successfully develop, verify and certify multiple software systems. The new commercial version features an enhanced architecture, an Eclipse IDE and a wealth of capabilities so that software developers can now automate the many tasks and processes required for their own large-scale, advanced software development and verification efforts.

[News ID 1581](#)

More information about each news is available on [www.Embedded-Control-Europe.com/magazine](http://www.Embedded-Control-Europe.com/magazine)  
You just have to type in the "News ID". —

You CAN get it...

Hardware & software for  
CAN bus applications...



Four-Channel  
CAN Interface

#### PCAN-PCI Express

CAN interface for PCI Express slots. Available as a single, dual, and four-channel version with galvanic isolation.



#### PCAN-Router

Programmable CAN router with 2 High-speed CAN channels. Available with D-Sub or Phoenix connectors.

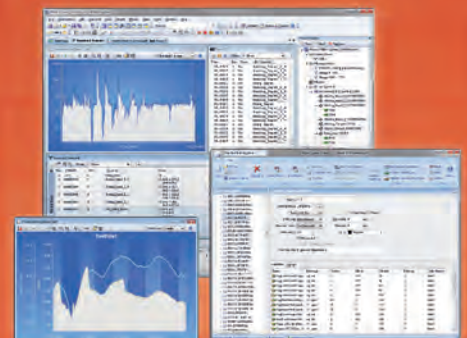

#### PCAN-Explorer 5

Universal CAN monitor, symbolic message representation, VBScript interface, integrated data logger, functionality upgrades with add-ins (e.g. Plotter add-in).

[www.peak-system.com](http://www.peak-system.com)

**PEAK**  
System

Otto-Roehm-Str. 69  
64293 Darmstadt / Germany  
Phone: +49 6151 8173-20  
Fax: +49 6151 8173-29  
info@peak-system.com



# Measuring energy consumption in embedded systems

By Peter Weber and Johann Zipperer, Texas Instruments

*Ultra-low power embedded processing systems challenge engineers working on system integration, as well as hardware and software designers optimising their portion of the overall system for energy efficiency. An energy measurement system allowing them to see the effects of various improvements helpfully supports development and debugging.*

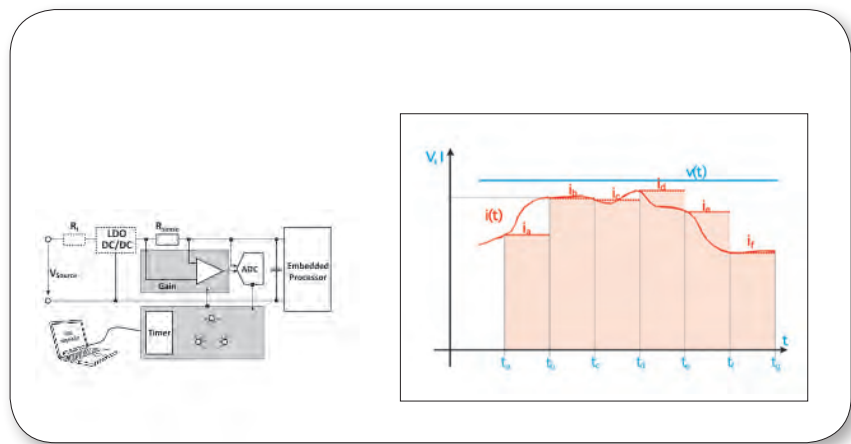

■ The energy measurement systems in ultra-low-power applications are usually powered from a DC supply and are subject to current profiles via numerous power modes and situations, a huge dynamic range of the supply current, and highly fragmented non-periodical task responses. The energy efficiency achieved via these methods can help extend the operating time of portable equipment using primary or secondary batteries. Another energy-sensitive area is energy harvesting applications that need very careful energy-optimised designs. The ability to accurately measure energy consumption and optimise it for various conditions widens the application of energy harvesting products.

The primary advantage of having an energy measuring method is to see the energy consumption during the development of the system hardware and software. Any enhancements or additions to the activity profile of the product as well as the impact of such additions, both negative and positive, can be measured based on the energy demand. The integrated development environment can offer energy-related debug support. For the majority of cases the relative energy consumption is the key value. In ultra-low energy applications many short interrupts or other events are a major contributor to the energy consumption. The measurement sys-

tem needs to catch such energy contributors enabling the development of ultra-low energy efficient designs. Electrical energy is defined by three factors: voltage, current and time of observation or consumption. The formula for the electrical energy is usually simplified to  $E = V * I * t$  which may or may not cover the real conditions in the application system. Most energy measurement systems measure voltage and current with discrete components like analog-to-digital converters. Any precise measurement of the energy requires a power (integral over  $v(t)$  and  $i(t)$ ) integrating sensor with high resolution and dynamic range. The precision of time is less of a challenge and it can be considered that the time delta ( $t_1 - t_0$ ) is in the range of microseconds or smaller.

The voltage in embedded processing systems is constant. It is typically stable enough to introduce no significant error to the energy measurement result. The voltage ripples on power supplies in such systems are minimal and in the millivolt range. Capacitors are placed within close distances to the terminal of the embedded processor for sourcing high current peaks and keeping the voltage stable. A shunt resistor and operational amplifier convert the current flowing through the shunt resistor into a voltage to be digitised with the ADC. The energy can also be measured in such a way that the product of current  $i(t)$  and

the time is used. A variant of this method is to replace the energy  $\Delta E$  that is used while keeping the voltage  $v(t)$  stable.

First, the focus is on the three parameters that are needed to measure energy i.e. voltage  $V$ , current  $I$  and time  $t$ . Two main sources of energy used with embedded processor systems are power supplies and batteries. Many systems use power supplies with an output capacitor and deliver a good dynamic load regulation. Such power supplies can be based on LDOs or DC/DC converters. Other systems use primary or secondary types of batteries. Even if these have a higher dynamic resistance they are capable of delivering a stable supply voltage. As mentioned previously, the V-I-t method uses A/D converters to get data about the voltage and current parameters.

The analog-to-digital conversion used to measure the supply voltage level for the energy calculation is precise enough to match accuracy requirements. A 12-bit ADC usually has more than 11-bit ENOB and delivers accurate results, which are in the 0.5 per cent range. Current measurement in ultra-low power systems faces the challenge of highly dynamic current profiles. The dynamic range of power modes is shown for some MCUs in table 1. The resolution can be considered to be better than 1ppm and 10nA.



Device Power Mode	Device A (16-bit)	Device B (16-bit)	Device C (32-bit)	Device D (32-bit)
	uA	uA	uA	uA
Active Mode <sup>1</sup>	10100	1600	8400	8100
RTCC Mode LPM3.5 <sup>2</sup>	2.5	0.36	0.9	0.7
Off Mode LMP4.5 <sup>3</sup>	0.18	0.05	0.02	0.18
Resolution of I <sub>Measure</sub>	.01	.01	.01	.01
Dynamic Range	>1,010,000 : 1	>160,000 : 1	>752,000 : 1	>810,000 : 1

<sup>1</sup> @ maximum frequency, peripheral will add additional current consumption  
<sup>2</sup> Real-Time Clock & Calendar Mode, EFM LFRC instead of 32kHz XTAL  
<sup>3</sup> Deepest Power Mode

The most general power modes are listed showing the huge dynamic range confronting the measurement system.

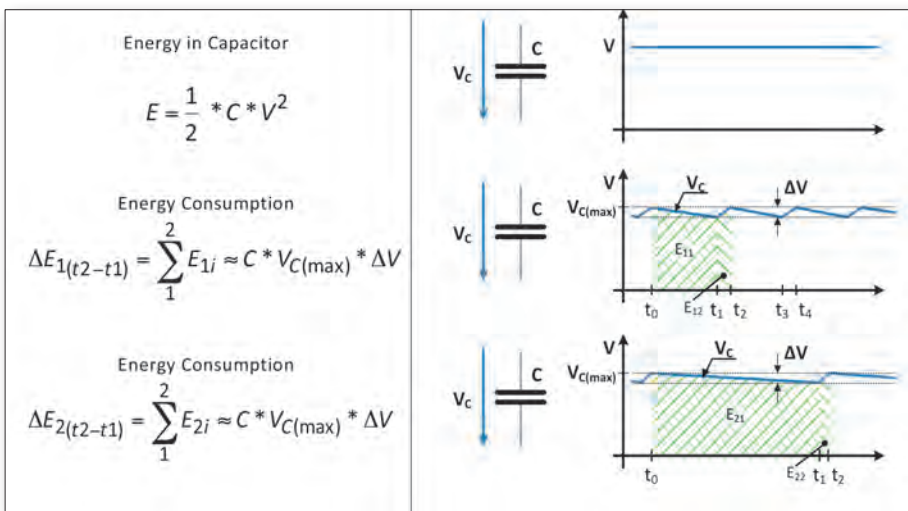

The principle of measuring discrete electrical energy

There are two common approaches for calculating energy usage. In the case of the V-I-T method for calculating energy, the basic measurement circuit uses a current sensing resistor, and precision amplifier with two sensitivity ranges, an analogue-to-digital converter and a timer. As shown in figure 1, the timer controls the finite state machine FSM (or a programmable controller). This in turn triggers the A/D conversion that measures the supply current and the supply voltage. The FSM or controller selects the gain of the amplifier system. The amplifier system can be built upon different implementation ideas getting the required gain needs resolved. The ability to allow for different gain settings is needed due to the huge dynamic range of ultra-low energy applications. Two possible designs are discussed. First, one amplifier is used and the controller decides to select the

low-gain or high-gain. This method is faced with the gain-select delay and hysteresis control needed for proper gain decision. A second option is to use two amplifiers and convert both outputs. For the final energy consumption the highest valid value can be used in the energy calculation. An important factor is the timing resolution and the precision of the current signal path. The discrete sampling of A/D results has an upper limit of conversions per second. The accuracy of the energy measure depends on the activity profile of the application system to report valid energy figures to the user.

On the other hand, the ΔE method for energy calculation uses an element to store energy to power the application. The simplest electrical component is a capacitor; and it is easily available and cost-effective. The electrical

energy in a capacitor is defined by the capacitance and the voltage across the terminals. The energy consumption is the voltage drop at the capacitor per time of the voltage drop. The basic principle to get the energy consumption for an observation period is to accumulate all individual delta charge (ΔE) events during that period. The capacitor element in this measurement principle is the integrator delivering the current to the high dynamic system load and is highly independent of the current waveform.

Ultimately, both methods have their strengths and weaknesses. If the main objective is to design the software and hardware for the best utilisation of the available energy the ΔE method has the advantage of integrating the current over time. The V-I-T method has advantage that the peak current can be observed as long as the events are long enough to be sampled effectively by the ADC. The bandwidth of the current-voltage operational amplifier system and the conversion rate define the accuracy of the system.

The energy measurement using the V-I-T method requires very fast, high resolution amplifiers and A/D converters with sufficient bandwidth in ultra-low power applications. The programmable amplifier requires fast load change detection and response down to the nA-range. The ultra-low power burst mode principle - which is the key to such ULP applications - is the driver for these requirements and poses challenges to develop the energy measurement system with acceptable resolution and accuracy level.

The ΔE method uses the integration capability for common passive components, a capacitor in the discussion here, to avoid the challenge and cost of highly precise electronic components and circuit. The consumed charge is reported individually or accumulated. The number of re-charge events results finally in the used energy. Slowly changing supply voltage, as it is typically for such applications, can be measured with simple A/D converters. Energy measurement is the most effective method to optimise applications for effective consumption by streamlining both software algorithms and hardware requests. Effective energy measurement techniques allow us to significantly improve battery life and open doors for a wider range of energy-sensitive applications. ■

**FREE SUBSCRIPTION to Boards & Solutions / ECE Magazine**  
 The European Embedded Systems Design Magazine  
[www.embedded-control-europe.com/magazine](http://www.embedded-control-europe.com/magazine)



# Wearable devices and the Internet of Things

The article is presented to you by Mouser Electronics

*Wearable devices are a hot topic these days, as illustrated by the new \$5,000 "Make it Wearable" challenge recently issued by Intel. This challenge will reward both visionaries and builders who conceive of or construct wearable applications that can shift personal computing into new innovative directions.*



*Health- and fitness-oriented wearable devices can offer biometric measurements such as heart rate, perspiration levels, and even complex measurements like oxygen levels in the bloodstream.*

■ Wearable devices are now at the heart of just about every discussion related to the Internet of Things (IoT), and the full range of new capabilities pervasive connectivity can bring. Some of these discussions often create more questions than answers. Perhaps that is natural given that we are still in the very early stages of their life cycle, but some questions need to be answered before a real “rollout” of wearable devices gets underway. For example, the wearable devices’ question on many minds these days is “Are wearable devices going to just be peripherals for a smart phone, or is there a more important role for them as part of the Internet of Things?” If we are really moving toward a more pervasive deployment of intelligence into just about everything in our environment, shouldn’t this apply to wearable devices too? In order to better ponder this question, let’s look at some of the key functions we can expect wearable devices to provide and some use cases to see how massively interconnected devices could provide additional capabilities.

Some of the first functions that wearable devices are already delivering are related to identification and security. Maybe you don’t consider the badge you wear at work a wearable device, but it does provide identification and security features useful within the work environment. Some advanced badges even

include some biometric capabilities (such as fingerprint activation, so only the badge’s owner can use it to open a locked door) to improve security. Badges can also include capabilities for location sensing, useful in emergencies to make sure everyone has successfully evacuated the building. A wearable bracelet provides a more reliable indication of location since it is less likely to be left in a jacket on the back of a chair.

Health- and fitness-oriented wearable devices that offer biometric measurements such as heart rate, perspiration levels, and even complex measurements like oxygen levels in the bloodstream are also becoming available. Technology advancements may even allow alcohol levels or other similar measurements to be made via a wearable device. The ability to sense, store, and track biometric measurements over time and then analyze the results, is just one interesting possibility. Tracking body temperature, for example, might provide an early indication of whether a cold or the flu is on the way.

Some additional capabilities of wearable devices are more mundane, but might also provide information that could be useful in adjusting environmental controls. Wearable devices could tell if you have your jacket on in the car or if it’s just in the back seat (perhaps

by placing a few stress measurement device threads within the fabric of the jacket). This could be helpful in keeping the car temperature at a comfortable level. If your wristband can measure perspiration levels that could also be used as a data point for adjusting both temperature and humidity.

The above examples could all use a smart phone as the central control for delivering these capabilities, but is that really the most efficient approach? Would it be better if Internet of Things (IoT) devices could communicate directly? You certainly don’t want to be required to use your smart phone to okay every transaction your wearable devices wish to make. Perhaps a better model is that the smart phone can help set up the modes of operation you want to support, as well as the privacy level you wish to enforce. Once the communication “strategy” is in place, all the devices can communicate in the ways you have allowed.

Let’s look at a simple example. Say you are wearing your smart watch, which is capturing your biometrics readings so that you can get an early warning of a possible illness (maybe because you were just on an airplane). Let’s further assume that you took the plane trip for a job interview and you are on your way into your first meeting. Do you want your bio-





*Wearable devices could be allowed to automatically connect to devices around the home too. Perhaps you have a preferred lighting level when watching TV from a particular chair.*

metric readings to be available to the person conducting the interview? Probably not. You could use your smart phone to protect your real-time biometric readings (and any history of readings) from access by the interviewer. Alternately, if your meeting wasn't for a job interview, but a yearly check-up by your doctor, you would want to allow access to all your biometrics.

Wearable devices could be allowed to automatically connect to devices around the home too. Perhaps you have a preferred lighting level when watching TV from a particular chair. You could turn on the TV and your wearable device could help adjust the lighting level from the connected LED lights within the room. An intelligent house might even support automatically blocking light from windows that created glare on the TV. Even the backlighting on the LCD TV screen could

be adjusted and all settings optimized for saving energy, as well as creating the most favorable viewing experience. All these interactions could be done automatically, directly between devices, once the overall strategy has been set via a smart phone interface.

The promise of the IoT is based on pervasive connectivity and when associated with large collections of connected devices, significant benefits can accrue. How can wearable devices benefit from this concept too? For example, could your wearable devices interact with the devices of others in a crowd? Would you want to know if someone sitting near you on the train had a high fever? Clearly you might want to know this, but the person with the fever might not want to broadcast it. If you both used the same healthcare provider; however, maybe that information would be shared, perhaps controlled via a smart phone filter. Privacy issues will continue to be a big concern for years to come, but there will be areas where some pervasive sharing of biometrics would be useful, or at least somewhat entertaining.

For example, consider a concert with a big crowd on the dance floor. If you were there, would you allow the DJ to access your heart rate (along with the heart rates of everyone in the crowd) to help choose the music (or to judge the effect his music choice has on the crowd)? That limited sharing of biometrics could be useful, and perhaps even "required" to get into the venue. It is conceivable that our wearable devices could even be used to get everyone dancing "in synch" as part of a new concert experience. Your wearable device could have an accelerometer included so your movements could be coordinated with oth-

ers on the concert floor. The DJ would select not only music but suggested "dance moves" as accompaniment. LEDs could even be included in your concert wearables as visual cues to show you what to do (or not do). It could be a massive Dance Dance Revolution experience.

A common element to these pervasive designs will be low power. One approach to achieving low power will be through energy harvesting. In the above example, harvesting energy from dancing and moving around will be easy, but in most cases battery-based designs will be the implementation of choice. You might think that battery operation will be a significant limitation, but for wearables at least, the high speed with which fashions change will mean that the battery is probably not the limiting factor. In fact, a wearable device will probably go out of fashion before the battery does! For wearable devices that have longer lifetimes, battery technology will undoubtedly advance to give us more power in smaller space and to more easily allow charging, perhaps from a short distance. Watches, armbands, and similar wearable devices could be easily recharged and provide the longer-term, higher-power functions required.

Clearly for these types of pervasive interactions, very intelligent and low-power MCUs will be required. High-end IoT applications will require significant processing and interface capabilities (including wireless options) along with advanced security capabilities such as secure boot. These advanced applications could use some of the newest devices, like the Intel Quark X1000 processors, to also leverage much of the existing software base to simplify development. Supporting a range of connectivity options allows for bridging and aggregation of content from multiple sources, which will reduce power requirements for the "peripherals" in the wearable device network.

Lower-end applications would just need to support connections to simple sensors, security, and low-speed wireless access all from a low-cost battery. MCUs like the Silicon Labs EFM<sup>®</sup>32 Zero Gecko can operate for long periods of time on very low current, so they can be easily used in wearable applications where sensing, processing, and storage are required at biometric frequency time intervals. Even these sensor-oriented devices can use some periodic processing power; however, since minimizing wireless data transmission times will offer the largest system power savings.

No matter what direction wearable devices evolve over the next few years, it seems that they will need to be a more integrated element in the IoT in order to provide the wide range of features we're all expecting. ■



*Pervasive sharing of biometrics - allow the DJ to access your heart rate (along with the heart rates of everyone in the crowd) to help choose the music (or to judge the effect his music choice has on the crowd)*

# A new era of modular application-ready systems

By Susanne Bornschlegl, MEN

*This article describes how the MEN approach to turn-key systems is emerging in the shape of a modular concept for different formats.*

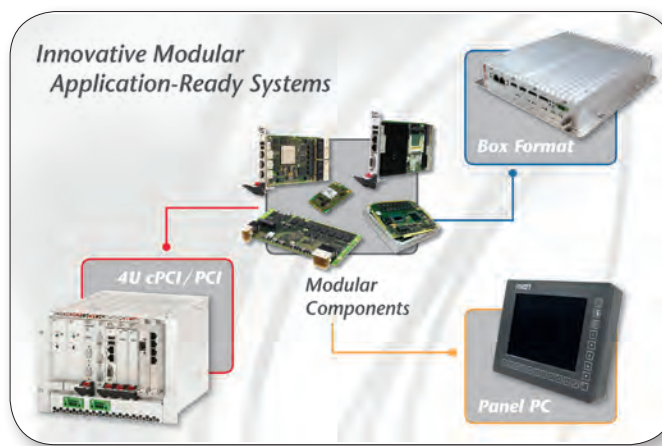

■ When it comes to embedded computer systems, every market and even every single application has different requirements in packaging, mounting, and of course performance and I/O functionality. Accordingly, a strongly focused market approach prevails in the offering of application-ready systems. It seems that manufacturers are forced to compromise. It's either robust design or high performance. Either compact size or configurable I/O. Either modular or inexpensive. The resulting systems out on the market differ on a large scale. Most of them, and at least anything called a box PC, have their own design with a rather rigid set of functions. Despite that, vendors seem to follow their competition as well as basic market trends regarding interfaces, housing design and supported temperature ranges. Unfortunately this leads to a lack in flexibility and modularity.

For a manufacturer focused on board-level products, the most flexible solutions use platforms like CompactPCI or ATX with configurable slots that can ideally be filled from the own component portfolio of the manufacturer. ATX or Mini ATX are built up mostly of PCI cards. More compact platforms like DIN rail PCs require special boards for most systems. In both cases, systems end up rather specialized, which makes them more expensive and less flexible for future extensions. Unsatisfied

with conventional ideas, MEN has raised the bar on turn-key solutions with clear goals: The time-to-market must be short, configuration must be easy even with special I/O requirements, any approach must be highly modular to save time and costs, and the final system must be ready for harsh environments. A clear vision and fresh ideas have come along and are already leading customers from different markets to a range of products that improve on existing solutions.

One basic idea that MEN standard products have paved the way for is built-to-order (BTO) systems. Computer systems are subject to extreme cost pressure, particularly in industrial areas like automation. On the other hand they need to be configurable. They need PCI components and fieldbus options. Ideally, everything has to come off the shelf to optimize the costs both on the manufacturer side and on the customer side. 19" CompactPCI with a standard height of 4U seemed the most solid standard basis, and a more compact system can use only half the horizontal pitch with 40 HP (9.5"). The harder part was to make it configurable in such a way that it can accommodate all kinds of I/O functions along with the PCI cards very common in industrial applications, without having to change the resulting backplane for different configurations. The backplane for an industrial PC

is built around a standard 3U CompactPCI (PlusIO) CPU board. An Intel Core i7 processor brings high CPU performance to industrial applications. This performance is scalable through an existing family of compatible CPU boards and results in lower maintenance and modification costs. The family concept also makes the system long-term available: when an Intel CPU is discontinued, a new compatible CPU card with an up-to-date processor will be in place. The CPU has a standard two Gigabit Ethernet interface, USB and VGA at the front and connects to high-speed serial interfaces via its PlusIO rear connector.

With such CPU flexibility at its heart, even an industrial PC can cover a broad range of possible tasks, including RAID, NAS, and kiosk or data acquisition functions. To implement the actual I/O functions, you can plug two CompactPCI and two CompactPCI Serial peripheral cards plus two PCI or PCI Express cards. These proven and reliable standards ensure the demanded modularity, and allow independence from a single supplier, if necessary. The two PCI/PCIe slots can be equipped with half-length cards for further customized extension. The industrial PC can be powered by two 6-HP AC or DC power supply units (PSUs) to provide redundancy. An uninterruptible power supply (UPS) guarantees continuous operation, or lets the operat-





APPLICATION?

# READY!

SYSTEMS FROM MEN

- *Built-to-order systems*
- *Configured from a pool of MEN standard hardware and software*
- *Pre-installed operating systems and drivers*
- *Ready for harsh environments*



*Rugged Computer Boards and Systems for Harsh,  
Mobile and Mission-Critical Applications*

www. **MEN**® .de





Figure 1. Built-to-order application-ready half-19" system

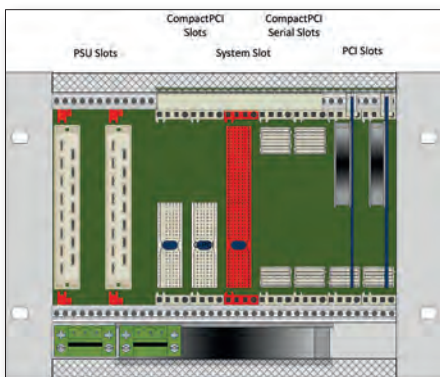

Figure 2. System set-up of MH701 built-to-order 9.5" industrial PC

ing system shut down gracefully. A carefully designed shelf controller adds supervision and a status panel. Its mechanical setup allows the system to be wall or rack-mounted. Cooling can be either by natural convection or by a fan installed in an additional fan tray at the bottom.

While this concept is not brand-new, it does take modularity to a new extreme. The pool of standard hardware available to build up a specific functionality includes all kinds of I/O for PCI, CompactPCI and CompactPCI Serial such as networking or mass storage, analog and binary I/O, or wireless interfaces. Additionally, MEN has partnered with Hilscher to offer fieldbus interfaces from CANopen, DeviceNet, Real-Time-Ethernet (EtherCAT, EtherNet/IP, Modbus, Powerlink, Profinet, Sercos,

Varan) to Profibus on 3U CompactPCI. The supported components have been selected to guarantee a complete range of options from a reliable source. In terms of power supply, MEN relies on its own experience and is launching a new family of PSUs that emphasize the modular approach. Depending on the market, PSUs can vary greatly. They have to handle a wide range of DC or AC input voltages, for instance. To facilitate certification procedures, the new products will fulfill the railway requirements of different geographical areas. Parallel and redundant modes let you connect power supplies inside a system to increase availability or power output. And finally, even the best hardware cannot be called application-ready without matching software. This is why the industrial PC always comes with a pre-installed operating system and drivers.

If that sounds like a solid base for many tasks, you should never forget how different embedded applications can be. There is no "Jack of all trades" solution. This has never been as true as it is today, with embedded computers finding their way into ever new fields of use. Engineers need to think outside of the box before actually designing it. The footprint of a 19" system may still be too large, its cooling concept may not work in restricted surroundings, its housing may not be robust enough. Instead of just seeing a world fall apart, MEN engineers have made these aspects part of their vision. If the market needs robust box PCs and other more dedicated systems, then why not do it properly? What they came up with is an impressive roadmap of devices embedded into a clear concept. A growing family of off-the-shelf box computers is one important pillar in this plan.

A number of standardized components can be assembled to build up all kinds of box PCs allowing for different CPU performance classes from ARM to AMD and Intel, numerous I/O configuration options and scalable housing sizes. A range of standard boxes cover dedicated functional areas to meet cost requirements and fast time-to-market. An important focus is on in-vehicle PCs comply-

ing with EN 50155 for rail and ISO 7637-2 for automotive. One compact box was designed for graphical performance and another slightly larger box comes as an all-rounder for wireless communication. With AMD, or alternatively Intel performance, it is combinable with displays or storage, while PCI Express Mini Cards, SIM card holders and antenna facilities leave the necessary room for configuration of the exact wireless functionality up to LTE (4G) or WLAN / Wi-Fi. A GNSS interface supporting GPS and GLONASS for positioning complements the possibilities. Also based on AMD is an industrial box PC optimized for cost efficiency and one for storage applications, including hot-pluggable HDD/SSD shuttles. Next up there is a number of Intel-based box PCs for even higher performance in storage and communication functions. One option for implementing a panel PC is to combine a suitable display and box PC. The box design was already prepared for that, too.

What these CompactPCI based systems and box PCs have in common is their modular, family-based design. Many design details are completely dedicated to one package concept, but many functions can be re-used and technologies can be shared between device types. Plug-on modules like PCIe Mini Cards can add wireless or legacy I/O functions and especially fieldbus interfaces. Hilscher modular solution for functions from CANopen to real-time Ethernet integrates perfectly into MEN systems, with CompactPCI peripherals and Mini Cards being based on the same functional unit. Reusing such units drastically reduces costs.

The mentioned system formats will soon be expanded by a family of routers and switches available both in box and 9.5" rack-mount CompactPCI format, similar to the different industrial PCs explained above. These are not just application-ready but true turn-key systems. The networking products are designed with one common PCB base. This will yield a complete range of ready-to-use devices optimized for different markets and performance levels. Beside upcoming application-ready RAID and NAS systems based on CompactPCI, very special systems are also under way for safe train control. These involve sophisticated design according to standards like EN 50128/50129 but use the same modular basis of 9.5" CompactPCI. They are combined with an existing 3U CompactPCI safe rail CPU card, safe rail I/O cards and safe software.

While MEN is not exclusively active in the rail market, this is where the most challenging designs have their origin. All the system-level products already available or coming up soon benefit from more demanding requirements.



Figure 3. BL50W box PC for in-vehicle wireless functions



Flexibility and modularity not only bring reliable, rugged design and competitive pricing to demanding markets, but also to industrial PC solutions or networking. The final question is whether even heavily configurable devices can keep up with the off-the-shelf idea. Even with a radically modular concept, can you just click and place your components online and put the system into a shopping basket for ordering? Yes and no, in a way. Complicated is an attribute that does not sound likeable

for a system that promises easy configuration, but a truly optimized solution deserves some degree of complexity. Customers face full racks of devices in all flavors in the embedded supermarket. Could the last modular piece in the puzzle of an application-ready system be an excellent partner who understands your needs? Your system will still be on your desk and in your project in very short time, but without the hassle of which components really match. That is part of the vision, too. ■

## Product News

### ■ Vecow expands ECS-7000 lineup with multiple IP68-rated M12 connectors

Vecow introduces the ECS-7000M series fanless embedded system. VECOW's ECS-7000M is perfectly designed for controlling, monitoring machinery for Power, Energy, Mining, Agriculture, Gas, Oil, Water, Factory Automation as well as Railway (EN50155-certified). By enhancing the continual connectivity with multiple rugged IP67 rated M12 connectors, max. three RS-232, one RS-232/422/485, max. four USB 2.0/3.0 and max. four GbE LANs, separately.

[News ID 1764](#)

### ■ Vector quantifies cost of fixing bugs versus preventing them

Vector Software released a new white paper that enables organizations to easily measure the impact that poor software quality has on their bottom line. Titled "Quantifying The Cost of Fixing vs Preventing Bugs", the paper enables companies to obtain concrete figures about how much buggy code costs their organization, and shows how an automated, repeatable software testing process helps companies improve software quality while reducing time-to-market.

[News ID 1759](#)

### ■ Aitech: space-qualified 3U CompactPCI SBC ready for orbit

Aitech Defense Systems announces that the SP0 3U CompactPCI SBC has passed final 100 kRad testing for use in low and medium orbits and has demonstrated high confidence for geostationary orbits. The SBC underwent intense radiation testing performed with 200 MeV protons designed to test total ionizing dose and single event effects for particles with linear energy transfer up to 15 MeV.

[News ID 1749](#)

### ■ MEN: safe CompactPCI PlusIO SBC with QNX support

The safe F75P single-board computer brings functional safety to the board level, using redundant Intel Atom processors. The safe QNX operating system and the corresponding certification package make the F75P a

SIL 4 certified turn-key solution. Two out of a total of three Intel Atom E680T processors are set up to be a redundant control unit with 1.6 GHz and 512 MB DDR2 RAM, running with a safe QNX BSP.

[News ID 1745](#)

### ■ DFI: COM Express Compact module uses 4th gen Intel Core U-series SoC

DFI unveils HU968, the most advanced COM Express Compact module in its fourth generation Intel Core product line. The new U-Series platform with BGA 1168 packaging technology features smart performance, high speed I/O, and low-power consumption at only 15W TDP. Thanks to its single-chip SoC design, HU968 efficiently saves more space and provides better connectivity in such a small form factor of 95 x 95mm.

[News ID 1740](#)

### ■ WinSystems: fanless quad-core embedded PC operates from -40 to +85°C

WinSystems is introducing a fanless quad-core Intel Atom E3845 based industrial computer. The SYS-405Q includes USB, dual Ethernet, mini-PCIe and serial ports housed in a rigid aluminum alloy enclosure. Designed for rugged applications, this industrial embedded system also features extended temperature operation and long-term availability.

[News ID 1729](#)

### ■ Curtiss-Wright: rugged dual XMC carrier 6U OpenVPX card

Curtiss-Wright has introduced the new VPX6-218, a rugged 6U OpenVPX XMC carrier card that enables system designers to quickly and easily add up to two XMC (VITA 42.3) mezzanine module cards to their OpenVPX-based embedded systems. The fully rugged carrier card, which supports 8-lanes of PCIe Gen2, provides designers with the flexibility to expand their system architecture with the exact I/O their application requires. Its high speed, low latency PCIe interface communicates with the host processor over the VPX backplane.

[News ID 1728](#)



❖ Low Power Consumption  
❖ High Performance  
❖ Energy Efficiency

## Avalue Embedded Platforms



### ECM-BYT ▶ 3.5" SBC Intel® Celeron®/Atom™ SoC Processors 3.5" Micro Module

❖ One SODIMM Up to 8GB DDR3L 1066/1333, Dual View, 2-CH 18/24-bit LVDS, CRT, HDMI, HD Audio, 2 GbE, 1 CF, 1 SATA II, 1 Mini PCIe, 1 USB 3.0, 5 USB 2.0, 4 COM, 8-bit GPIO



### EQM-BYT ▶ Qseven Intel® Atom™ SoC Processors Qseven Module

❖ Onboard DDR3L 1066/1333 Up to 4GB, 2-CH 24-bit LVDS + HDMI, 2 SATA, GbE, 5 USB 2.0, 1 USB 3.0, 3 PCIe1, Fanless Operation



### ESM-QM87 ▶ COM Express Intel® 4th Generation Core™ i7/i5/i3 COM Express Type 6 Module

❖ Two SODIMM Up to 16GB DDR3L 1333/1600, 2-CH 18/24-bit LVDS, VGA, DP/HDMI/DVI, eDP Option, HD Audio, GbE, 7 PCIe1, 1 PCIe16, 4 SATA, 8 USB 2.0, 4 USB 3.0, 8-bit GPIO, SMBus, LPC, Type 6 Pin-out



### EPS-QM87 ▶ Embedded System Fanless Intel® 4th Generation Core™ i7/i5/i3 Rugged Embedded System

❖ Intel® Core™ i7/i5/i3 w/Intel® QM87 Chipset, Two SODIMM Up to 16GB DDR3L 1333/1600, Triple Display, HD Audio, 2 GbE, 2 SATA III, 2 SATA II, 8 COM, 8 USB, 1 LPT, 2 PCI, 2 Mini PCIe, 1 SIM Card, 8 In/8 Out GPIO



### BFC-10W7 ▶ Multi-Touch 10.1" Multifunctional Full Flat Multi-Touch Panel Computer

❖ Intel® Atom™ D2550 w/Intel® NM10 Chipset, GbE, Audio, 1 VGA, 1 HDMI, 2 LAN, 1 CF, 2 COM, 3 USB 2.0, Optional WiFi Module, Fanless Operation, VESA Compliance, IP-65 Compliant Front Panel



### PPC-1727 ▶ Multi-Touch Fanless 17" SXGA TFT Multifunctional Plastic Panel PC

❖ Intel® Atom™ D2550 w/Intel® NM10 Chipset, GbE, Audio, 2 x 2W Speaker, 1 CF, 2 USB, 2 COM & 1 Mini PCIe, Power-On Timer, Wide Voltage +12V ~ +28V, ErP Power, Fanless Operation, VESA Compliance, IP-65 Compliant Front Panel



### Rity152 ▶ POS 15" ALL IN ONE Fanless POS Terminal

❖ Rich I/O (Including 6 USB, Optional HDMI & CAM), Front IP-65 & Back IP-41, Fanless, Service Windows for RAM and HDD, Support Cash Drawer (12V/24V), DC +24V Output, 5-wire Resistive Touch (Optional Multi-touch), Optional Device: MSR, VFD, Stand, 2nd Display



7F, 228, Lian-cheng Road, Zhonghe Dist.,  
New Taipei City 235, Taiwan  
sales@avalue.com.tw  
TEL: (886) 2 8226 2345 FAX: (886) 2 8226 2777

**avalue**  
Technology Inc.



# COM Express Type 6 module family with latest Intel Atom technology

By Konrad Löckler, MSC Technologies

*MSC Technologies offer predefined building blocks for complex embedded systems and robust industrial computers with differing requirements. Products are based on standardized Computer-On-Modules (COMs), various baseboards and suitable computer housings that can be quickly and easily combined into robust computing solutions.*

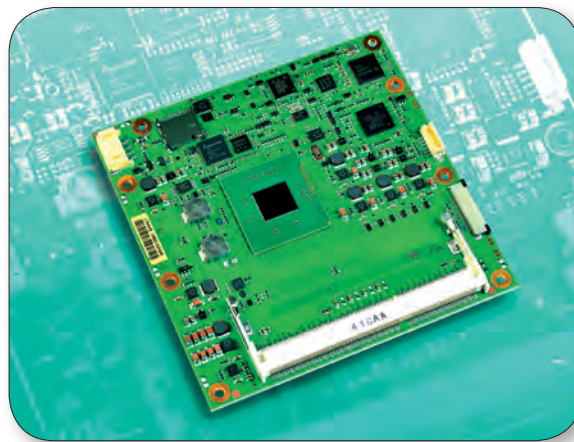

*Figure 1. The MSC C6C-BT COM Express Type 6 module with E3800 Intel Atom platform is one of the new building blocks.*

■ The rapid innovation cycles and dynamic developments in the PC industry for consumer applications also affect the market for industrial computer systems. However, in contrast to the traditional information technology (IT) business, additional system features are required here. The specific requirements range from scalable computer and graphics performance, special input/output interfaces and robust housings through to designs that function without rotating parts such as fans. Furthermore, in addition to the long lifecycle of all components, above all security of the platform and long-term availability of the product play an important role. Compliance with certain protection classes is also required depending on the industrial application.

Since time-to-market must be continually optimized and at the same time innovative embedded systems are becoming increasingly compact and more complex, system developers are today faced with the difficult task of choosing the right solution for their specific requirements. A particular challenge here is the development of embedded solutions for future markets such as home automation, smart energy and the Internet of Things (IoT). The interaction between hardware, software and the mechanical design plays an ever more important role here in these modern systems. These interesting future markets

promise extremely large quantities over the next few years. For the realization of powerful embedded system solutions with varying requirements for use in everyday industrial conditions, MSC Technologies focuses on predefined building blocks. Using these scalable modules customer-specific systems can be built within a short space of time at optimized costs – lengthy product developments become unnecessary. The solutions are based on standardized Computer-on-Modules (COMs), various baseboards, flexible industrial housings, cooling solutions, memory modules and solid state disks (SSDs). The complete system can be extended at any time. For example, a hardware upgrade from an Intel Atom processor of the previous version to the latest Intel Atom processor E3800 product family merely requires exchanging the standardized COM.

A continuous platform strategy and an extensive range of standardized building blocks are important factors in order to quickly realize optimized system solutions. This makes it possible to build compact, robust industrial systems for various applications including industrial automation, medical, transportation, in-vehicle infotainment and safety systems as well as for the digital signage, point-of-sale (POS), kiosk and gaming sectors. The most important task for MSC is the definition of suitable building blocks for the differ-

ing requirements of customers and the rapid provision of these modules. With standard products, the company is positioned to take specific project requirements and implement them quickly into reliable industrial systems. In this way, the company is therefore able to offer numerous customers an easy start into the embedded computing market. The embedded modules are characterized by their scalability of processor and graphics performance. These modules are based on low-power Intel Atom processors, high-end 4th generation Intel Core processors as well as various ARM processors. For many years, MSC Technologies has been developing and manufacturing high-quality Computer-on-Modules (COMs) in large quantities in Germany.

The MSC C6C-BT COM Express Type 6 module is one of the most interesting new building blocks. Like the MSC Q7-BT Qseven module, the new COM Express module is based on the latest Intel Atom processor E3800 product family (figure 1). In comparison with the previous generation of Intel Atom processors, the new multicore processors integrate a completely revised architecture and offer significantly higher computing and graphics performance with low power consumption. The performance/watt-optimized Computer-on-Modules (COMs) enable numerous new system developments in various markets

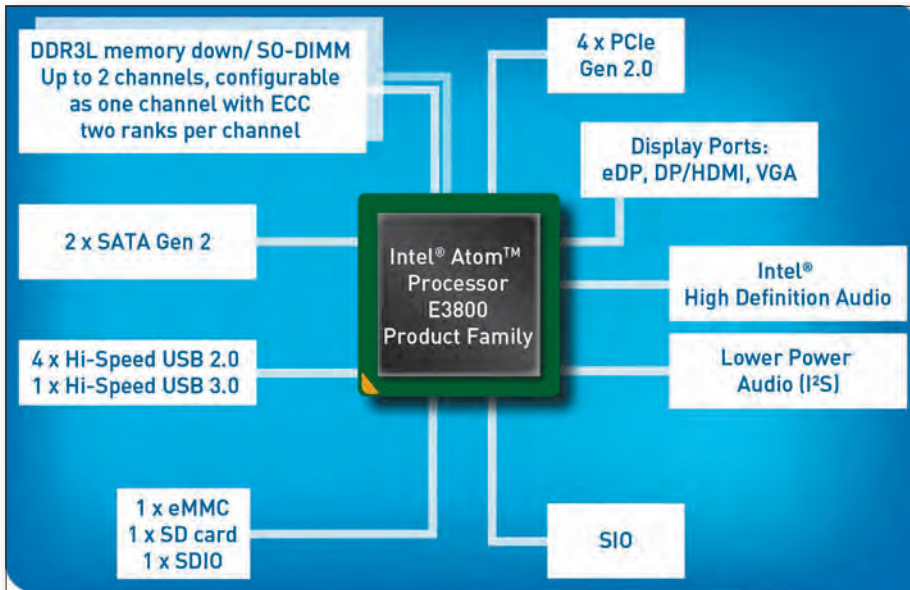

Figure 2. Block diagram of the new E3800 Intel Atom platform (Source: Intel)

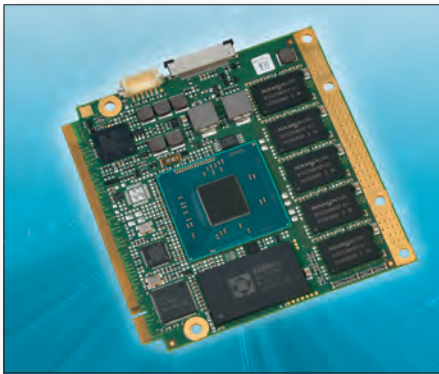

Figure 3. The MSC Q7-BT Qseven 2.0 modules are specified for the commercial and industrial temperature range.

wherever compact design and fanless operation are vital. As one of the leading manufacturers of innovative embedded modules, MSC immediately included the long-awaited Intel Atom processor E3800 product family in their high-performance products. The company offer modules in various performance categories and price ranges as well as in both Qseven and COM Express form factors. The Intel Atom processor E3800 product family utilizes Intel 22nm process technology with 3D tri-gate transistors. These processors are not only available in single-core and dual-core versions, but also now for the first time in more powerful quad-core versions (figure

2). In comparison with previous-generation Intel Atom families, the latest E3800 product family features an enhanced microarchitecture, the introduction of out-of-order execution, the integration of powerful graphics and an improved power management. The processors support Intel 64 and Intel Virtualization Technology (VT-x), which, like the built-in security engine, ensures a high level of security of the platform. The Intel Atom platform supports memory with error correcting code (ECC), which ensures high data integrity, reliability and system availability. This is especially important for equipment in factory automation operating 24/7. With the Intel Advanced Encryption Standard New Instructions (Intel AES-NI), the data to be transmitted and stored can be encrypted in real-time without loading the CPU. The sophisticated power management ensures low energy consumption with comparatively high computational performance. Numerous power saving modes and the Intel SpeedStep technology are supported.

The MSC C6C-BT COM Express Type 6 module platform is offered in seven variants. The most powerful module based on the E3845 (1.91GHz, 10W TDP) for the first time offers a quad-core Intel Atom processor on x86 COM Express form factor. In addition MSC presents modules with dual-core processors E3827

(1.75GHz, 8W TDP), E3826 (1.46GHz, 6W TDP) and E3825 (1.33GHz, 6W TDP) and - for less demanding applications - the cost-efficient single-core E3815 (1.46GHz, 5W TDP) Intel Atom processor. Besides these Atom based products there are Computer-on-Modules with N2920 (1.86/2.00GHz, 7.5W TDP) and J1900 (2.00/2.42GHz, 10W TDP) Intel Celeron processors with four cores available. Both processors offer a turbo-mode to enhance the peak performance. The integrated Intel Gen 7 HD Graphics bases on the Graphics Engine known from the Intel Core processors and offers significantly improved 2D and 3D graphics. DirectX 1.1, OpenGL 3.2 and OpenCL 1.1 are supported. The video decoding hardware acceleration covers H.264, MPEG2, MVC, VC-1, WMV 9 and VP8 formats. The embedded modules can be equipped with up to 8GB dual-channel DDR3 SDRAM.

The MSC C6C-BT COM Express Type 6 module family in the compact form factor of 95 x 95mm offer a USB 3.0 port, seven USB 2.0 ports, Gbit Ethernet and PCIe x1 lanes, LPC, HD audio, I2C, SMBus, SPI Bus and two SATA 3 Gbit/s interfaces. A socket for MicroSD cards is a unique feature in this product class. For the connection of two independent displays, a display interface for DisplayPort, HDMI and DVI, an embedded DisplayPort (eDP) which can be switched to LVDS and VGA are available. The resolution of the display interfaces is up to 2560 x 1600 pixels.

MSC Technologies offers a starter kit, carrier boards, memory modules and sophisticated cooling solutions for its C6C-BT platform. The embedded modules are optionally available for both the commercial and industrial temperature range. Furthermore, the company will introduce COM Express Type 2 modules to replace the discontinued Intel Menlow, N270 and Core 2 Duo processor based platforms. These modules will support the older PCI and PATA/IDE interfaces. For compact systems, MSC Technologies offers its MSC Q7-BT Qseven module family also based on the Intel Atom processor E3800 product technology (figure 3). Today, the cost-optimized product is available in five variants, e.g. with the quad-core E3845 Intel Atom processor. The MSC QT-BT Qseven 2.0 modules are specified for the commercial and industrial temperature range. ■



**smart.efficient.cool.**  
TMCM-1043-KIT Stepper-Motor Driver Development System

PC-based GUI that allows one-click modification of key parameters for robotics, lab automation and other stepper-motor applications.

discover more on [trinamic.com](http://trinamic.com)





# SyncE, IEEE1588, and GPS receiver options extend MicroTCA applications

By Justin Moll, VadaTech

*MicroTCA is already used in many communications, medical, networking, Mill/Aero, and research/physics applications.*

*But, by adding GPS Receiver, SyncE/IEEE1588 and other features to the MCH, MicroTCA should see increased adoption in these markets.*



*Figure 1. By providing a GPS receiver and IEEE1588/SyncE on a 40G MicroTCA Carrier Hub (MCH), today MicroTCA systems can provide precision timing for many applications.*

■ Precision timing is a key element in various applications. Having synchronized timing is critical to provide the highest Quality of Service (QoS) and reliability in deterministic computing systems. In applications from radar to networking to beam position monitoring, voice or video over IP, and many others, the need to synchronize the timing of networked nodes with the system is critical. By providing precision timing within one compact high-performance system, significant system costs and space can be saved, with higher reliability.

A network is disciplined to the timing of a GPS clock or set to an arbitrary clock that keeps time for the system. GPS is used in many airborne, naval, and other applications that are mobile, but also across a terrestrial network of cell towers for IP traffic. Regardless of the type, how a system is attuned to the GPS or other clocking is important. The clocking of the system can be important in terms of having accurate time for human interface – to see the actual time of events. The transmission side of the equation is equally important. The timing of when data is sent/received in the system can make a significant difference for buffering and packet loss in data streams. In addition, precision timing is critical for aligning separate nodes into a combined synchronous event, i.e. physics lab

tests. It is also a key basis point in algorithmic equations for precision in radar/targeting. One concern in Ethernet-based transmission of data is the timing between the sender and the receiver. There needs to be some buffering to help the receiver catch up if it is slower than the sender. But, there is only so much buffer storage available before some packet loss occurs. Ethernet was not designed to ensure the sender and receiver was synchronized. But today, Synchronous Ethernet (SyncE) can ensure the receiver never has a buffer overflow resulting in packet loss. Providing SyncE in an embedded system improves QoS for all types of applications using heavy data packets, such as video over IP. Whether it's a video processing system for broadcasting a sporting event or electronic surveillance over an IP network, SyncE is a key vehicle.

Figure 1 shows a MicroTCA Carrier Hub (MCH) with SyncE/IEEE1588 and GPS receiver options. MicroTCA was chosen as the form factor as it is one of the most powerful and versatile open COTS architectures in the embedded market. While SyncE captures the frequency and phase, IEEE1588 is the time side of the equation. IEEE1588 calculates the difference between the timing of the clock it is using versus that of the grand master clock (GMC). An example of the importance of SyncE/IEEE1588 is in a radar application.

Ten years ago, a weapon system would have the radar as part of the system or a short distance away. Nowadays in network-centric warfare, the radar and weapon system can be many miles away. In sending and receiving data, by the time the system receives the input and is ready to analyze the data, the



*Figure 2. An application-ready platform providing five Virtex-6 or Virtex-7 FPGAs and a P5020 QorIQ Processor in small chassis designed for SWaP. Adding the GPS/SyncE features to this chassis expands the capabilities within the application.*

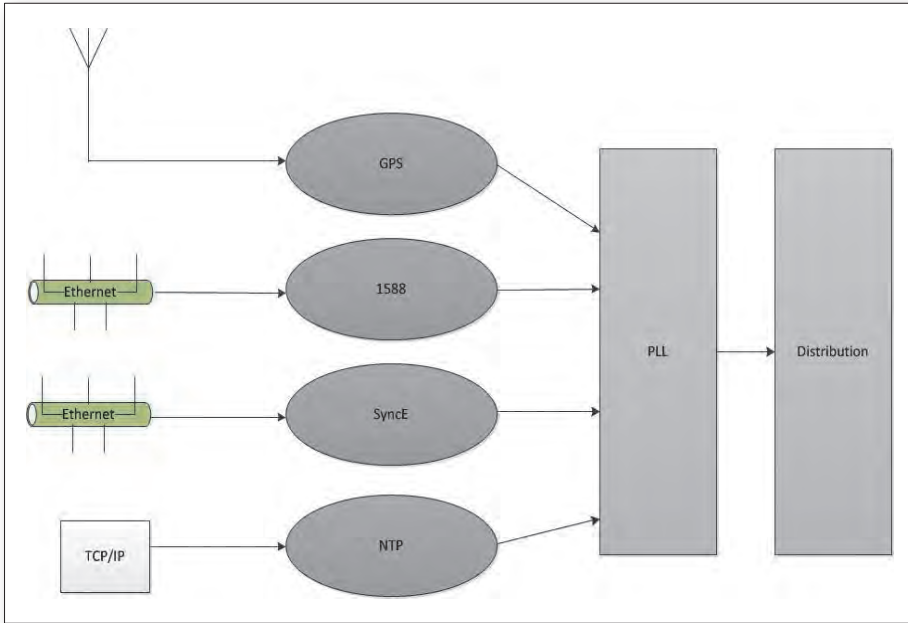

Figure 3. The diagram shows the antenna, Ethernet, and TCP/IP traffic types going through a phased locked loop clock synthesis/jitter cleaner for distribution.

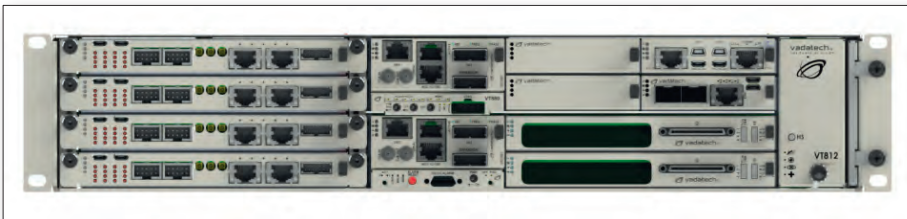

Figure 4. The physics and video processing community uses the MicroTCA.4 form factor with rear I/O option and signal conditioning. The 2U chassis shown has a mix of MicroTCA.4 and MicroTCA.0 boards.

target is in a different location. With SyncE and IEEE1588, the packet is time-stamped to the exact GMC time when it is sent. When the packet is received, the system can adjust the time differential and allow the algorithms to predict the location of the target. Therefore, the precision-timing of the system can help make targeting more accurate.

Figure 2 shows a Mil sensor application-ready platform with an MCH with GPS/SyncE/IEEE1588 and 5 FPGAs from Virtex-7 to Zynq-7 in a 7U Cube format chassis. As MicroTCA has system management as a key element within the system, the chassis can have 99.99999% uptime. This includes redundant cooling with failover capability, management of all of the FRUs within the system, etc. Having a more compact system is important for SWaP (Size, Weight, and Power) concerns for many Mil/Aero applications. Software can be used to time-stamp packets. However, that approach is not nearly as precise and reliable as having the time-stamp within the hardware as part of the PHY layer. The software simply won't have the resolution to achieve the goals effectively. In mission-critical applications, the timing disciplined to GPS must be

dropped due to the location or environment. A Stratum-3 (or TCXO) crystal for timing can keep precise timing and frequency (including 1pps regeneration) while out of GPS range, called auto hold-over time. This helps prevent dark spots where receiving a transmission is weak or not available. For example, a submarine may need to go underwater for several hours or days but stay attuned to the timing/frequency. It is also possible to provide Ethernet time services to the chassis networks on both the GbE and 40GbE fabrics via the MCH. The MCH can be subordinate to an external PTP or NTP master server. Alternatively, the GPS receiver can act as a grand master clock utilizing the precision timing information provided via the receiver and on-board disciplined oscillator. In MicroTCA and most embedded systems, to discipline the clocking of the system, the system vendor historically has had to customize the unit to the customer frequency. Utilizing a phased locked loop (PLL) allows the user frequency to be set-up and/or changed via a software configuration file to virtually any frequency. The customer only needs to provide the frequency (or upload it via software) used in the application and it can be instantly set remotely without

EMBEDDED  
NEWS



Embedded-News.tv  
The Video Portal for the European Embedded Market

Technical Videos,  
Video Interviews,  
Demos & more about:

- Chips & Components
- Tools & Software
- Boards & Modules



customization. The PLL also has the benefit of cleaning the signals for low-jitter, low-skew, and low-latency. Figure 3 shows the various timing protocols going through the PLL for distribution. The ability to assign the frequency remotely is critical for any application where it may be difficult to reach the modules (such as a remote outpost, satellite, or location that takes a lot of set-up/teardown). On a similar note a virtual JTAG option also helps in these settings.

The JSM provides a mechanism for an engineer to attach dongles for test and debugging and software uploads. There are many instances where physically connecting a dongle to the system may not be easy or desirable. A virtual JTAG allows the user to de-bug or re-program the system remotely. Clean signaling, precision timing, and a virtual JTAG are particularly enticing for high-energy physics applications, which have selected MicroTCA as the architecture of choice.

Figure 4 shows a 2U MicroTCA.4 chassis with rear I/O options. The chassis utilizes the 40GbE option of the MCH along with ADC and processor module options with signal conditioning which are beneficial for physics and video processing applications. Utilizing double modules (150mm high) versus the common single modules (75mm high), there is ample space for multi-core processors to have richer features such as RAID options, more on-board memory, serial over LAN, a Platform Controller Hub, and more front panel I/O. For video processing applications, particularly for live broadcasting, the system needs to have very high-bandwidth and precision-timing. A system with real-time processing and advanced clocking/timing is ideal for this type of environment. The low packet loss offers a significantly higher Quality of Service (QoS). ■



InnoTrans Hall 2.2 Stand 207

**Elma. Embedded where quality is imperative.**

Elma System Solutions provide safety and reliability to the Railway market. We provide electronic equipment for railway control, passenger information systems, rail signalling, video surveillance and security concepts. We fulfil the industry's most challenging standards. We are ready for the next project.

**We are ready for your project.**



Please call us for more information:  
+49 (0)7231 9734 0 • info@elma.de  
www.elma.com



**Product News**

■ **Advantech: COM Express Mini Module powered by Atom E3800 & Celeron N2930/J1900**

Advantech announced the debut of SOM-7567 COM Express Mini Type 10 module, featuring Intel Atom E3800/Celeron N2930/J1900 with significant CPU and graphics performance improvements. Measuring only 84 x 55mm, SOM-7567 supports onboard memory up to 4GB and 64GB flash memory, making it a perfect fit for portable applications and rugged requirements.

[News ID 1666](#)

■ **VadaTech upgrades its line of AMC storage modules**

VadaTech has upgraded its line of AMC Storage Modules with higher transfer rate, RAID and Host Bus Adapter options. The first in the line of upgraded storage AMCs is the AMC626. The module meets the AMC.1 specifications for use in MicroTCA and AdvancedTCA systems. It comes in the single module, mid-size and holds a 2.5 inch drive for SATA III at a 6 Gbps transfer rate or SAS-3 for a 12 Gbps transfer rate.

[News ID 1659](#)

■ **congatec certifies Qseven module for Intel gateway solutions for IoT**

congatec announces that the conga-QA3 Qseven module based on the Intel Atom processor E3800 family is now certified for the Intel Gateway Solutions for the Internet of Things. The company has paired its embedded computer with the validated software package from Intel, Wind River and McAfee to provide new services based on the connection of devices with each other and the cloud.

[News ID 1658](#)

■ **Kontron: mini Box-PCs with IoT gateway solutions from Intel**

Kontron launches the new KBox A-201 mini Box-PCs supporting Intel Gateway Solutions for the Internet of Things. In combination with Kontron's embedded application programming interface KEAPI, these application-ready machine-to-machine platforms offer IoT gateway intelligence that is highly sophisticated, standardized and easily deployable.

[News ID 1657](#)

■ **DFI: fanless embedded system based on Atom E3800 targets car PC application**

DFI launches its stylishly, slim EC700-BT that supports the low-power and high-performance Intel Atom™ processor E3800 product family. It is a perfect combination of impressive fashion design and excellent computing capability, bringing a new art concept to the industrial automation market. Aimed at Car PC application, you can replace the hard drive with a DC to DC Car PC module that supports ACC feature, and instead use mSATA for data storage support.

[News ID 1651](#)

■ **congatec: Qseven and COM modules boost performance with „Steppe Eagle“ processors**

congatec has expanded its Qseven and COM Express product range with modules based on 2nd generation AMD Embedded G-Series SOC processors. Compared to the current AMD Embedded G-Series SOC platform, they provide higher performance and a lower power draw thanks to an improved Jaguar+ CPU architecture and AMD Radeon 8000 graphics core.

[News ID 1643](#)

# Public transport revolution by contactless ticketing system

By Reinhold Mühlich, MCS

*An electronic ticket validating machine, the IVU.validator, has been developed and manufactured by MCS for IVU Traffic Technologies AG. A project of the Association of German Public Transport Providers (Verband der deutschen Verkehrsunternehmen), it enables automatic, cash-free and contactless payment valid across all participating transport providers.*



*Figure 1. The e-ticketing validator by IVU Traffic Technologies enables contactless payment.*

■ How do you succeed in buying the correct bus or train ticket these days? Complicated user menus at ticket vending machines can often baffle the most tech savvy users. Even in the best case scenario, purchasing a ticket from a vending machine takes valuable time. When a passenger has finally gotten their hands on the necessary piece of paper, the next question is whether the ticket needs validating before departure. Rules vary from one place to another. Not having the correct change, complicated vending machine menus and incomprehensible tariffs with zones, peak and off-peak times and strip tickets can easily turn travellers willing to pay into involuntary fare dodgers. The current paper-based ticketing system is complicated and time-consuming for the users of public transport; for the providers it is expensive.

To ease the situation, e-ticketing systems are being rolled out across many cities. The German capital Berlin, for instance, has already installed e-ticketing for many routes. E-tickets make the ticket buying process easier and faster for passengers. Sometime in the near future the entire travel chain - from trams, buses, coaches, underground, commuter and long-distance trains to planes - will be covered by a single medium. It will then be possible to travel with all types of transport and providers without having to think about fare

zones or battling with ticket machines. Customer comfort increases. With the purchase of an e-ticket, the passenger is in possession of a permanent ticket. Upon boarding the passenger swipes this e-ticket over a validator which registers the boarding station. When getting off, the e-ticket is again swiped over the validator to register the destination stop. The passenger is billed for the distance travelled. It is up to the respective transport provider to decide whether payment is taken automatically from a pre-loaded card or invoiced. The traveller can rest assured that he is always in possession of a valid ticket and that he will only pay for the distance travelled. The e-ticket replaces the flat-rate tariff system with one based on actual usage. The contactless validation of an e-ticket makes boarding a bus or train much faster than when the ticket needs to be inserted into a validating machine.

A contactless ticketing system benefits both passengers and transport providers. The transport company gets accurate statistics on the number of passengers at each stop and can tailor its services to the demand. The analysis points to potential savings while improving the service at peak times. Stops get shorter because boarding is faster. The contactless system is also immune to tampering attempts. There is less risk of vandalism because there are no slots to stick chewing gum into, for

instance. The few e-ticket vending machines that are still necessary can be stationed in central, well-monitored sites. The transport companies save money and increase their revenues because the need to mail monthly tickets or print paper tickets disappears. With fewer vending machines and easier cash logistics, maintenance and repair costs also decrease. The number of fare dodgers is likely to decline. The contactless ticket concept with the IVU.validator is already internationally successful. In Colombia, for example, approximately 600 buses are equipped with the IVU.validator.

The e-ticket includes RFID and communicates contact free over a distance of up to four centimetres from the validator. The technical concept of the VDV core application provides cryptographic methods to verify mutual authenticity. Ticket and validator can be sure that the received data is valid and the source of the data is authentic. While it was easy to forge a paper ticket, an e-ticket is much more secure. The e-ticket with RFID has a systemic advantage compared to solutions with a magnetic stripe or chip: dirty contacts or worn magnetic stripes simply do not exist. Because the communication is contactless it also works in dirty, grimy environments. Since the contact-free technology is hygienic and the equipment easy to clean, there are plans to extend the e-ticketing sys-





Figure 2. Qseven Computer-on-Module concept with carrier board and computer module

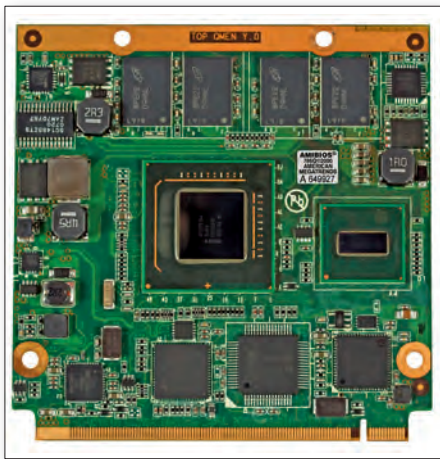

Figure 3. conga-QA Qseven Computer-On-Module with Intel Atom Z530 processor

tem to include services related to travel, such as parking garages, car-sharing pools or even food outlets at train stations. The IVU.validator controls the public transport entry and exit points. Cryptography enables it to securely communicate with the RFID of the e-ticket, record account details and forward them. An optional touch screen with brightness sensors adjusts to lighting conditions making it easy to read at any time; even the card reader antenna is illuminated. The validator supports ISO14443 (A/B) contactless smart cards and NFC devices according to ISO/IEC 18092. It can also scan and check tickets with barcodes (1d/2d). GPS provides information about the location, while the validator itself communicates via UMTS. All these features require computing power. More ideas and requirements are likely to be added in the future. At the same time the system is designed for low power consumption, because it feeds off the vehicle battery when installed. Therefore, precautions against voltage dips, transients and other disturbances have been built in. Because the validator is installed on-board the vehicle, it has a mechanically robust design that is shock, vibration and vandal proof and specified for the extended automotive temperature range. IVU Traffic Technologies is a large software company whose core competence lies

in the development of IT solutions for public passenger and freight transport and transport logistics. 350 employees from 15 nations at 8 locations design software, develop concepts, implement systems, streamline operations and advise more than 500 customers. The e-ticketing system required a powerful device, so IVU Traffic Technologies went looking for a partner with experience in the development and manufacture of devices suitable for installation on-board vehicles.

Since 1977, MCS has been developing and producing customized high-tech solutions and devices such as machine control and payment systems, GPS modules, printers and modems that are subject to extraordinarily harsh requirements in outdoor use. MCS received the ISO 9001-certificate supplement from the German Federal Motor Vehicle and Transport Authority (KBA, Kraftfahrt Bundesamt) for hardware and software development, production, sales and service of equipment and components in the areas of self-service terminals, machine control and metrology. This KBA-certification allows MCS to build devices for use in vehicles. The company also has the required bus and rail expertise. On-board electrical systems in such vehicles are prone to numerous faults, transients and spikes, facts that need to be accounted for in unit sizing. Since the company also has experience in the development and manufacturing of contactless payment systems, they were a perfect fit for IVU's requirements.

MCS assumed full product responsibility for the development of the IVU.validator, including development, specification, design, construction, mould, hardware and software development, prototyping, pre-production and series production. The company made sure that all designs are economical to produce and qualitatively feasible. Their in-house production facilities were another plus point compared to a pure development partner. The result is a validator that is EMC proof, shock and vibration resistant and compliant with industry standards. Inside the aluminium and plastic housing sits the COM module conga-QA/Z510-1G from congatec which provides the necessary computing power.

The VDV technical concept and specifications require a flexible and secure solution for an interoperable, modern ticketing system that is also capable of handling yet unknown future requirements. For this very reason, MCS chose to base the IVU.validator on COM technology. The strength of the COM concept lies precisely in its flexibility for future developments. COM is a standard for which many manufacturers offer processor modules. As long as only the standard properties are used within a COM form factor, the solution is ven-

dor independent and any module of the form factor can be used. A COM module contains the processor with the necessary peripherals and supplies. It is effectively a complete computer. The COM module is mounted onto a custom carrier board, which houses all application-specific properties. The combination of COM module and carrier board yields an application-specific device with the latest computing power. The crucial know-how remains in-house. COM manufacturers such as congatec have specialized in the development and production of these off-the-shelf pre-configured modules. MCS opted for the congatec module conga-QA/Z510-1G, based on the x86 Atom platform, because of its low power consumption and moderate costs. Another factor was the physical dimension of the module, because space inside the validator is limited.

Another advantage of the COM concept is its scalability. Within an application the need for computing power can vary. The market offers compatible COMs with a variety of processors that all work on the same carrier board. This makes it possible to select the optimum module within a product family from a price/performance standpoint. This is exactly why the IVU.validator won a project in Switzerland. The Swiss project required higher graphics performance and larger memory configuration for successful implementation. The validator normally uses conga-QA/Z510 module; however, by exchanging it with the conga-QA/Z530, a module with higher performance, the validator won the business. The more powerful solution was presented much earlier than the competing product. By using the COM concept, MCS is able to develop customer products more quickly than would be possible with separate processor developments. New devices are created by combining a proprietary carrier board with a processor generation that is appropriate for the application. This usually requires only minor adjustments.

For six years, MCS has been working with congatec and using their COMs for demanding customer applications. The collaboration has developed into a trusted partnership with close technical and commercial support. Although the modules themselves are standardized, successful implementation depends on details such as the supplied firmware, software, operating system modifications and/or design support. All congatec modules come pre-integrated with many standards and real-time operating systems and include all necessary peripheral drivers. In turn, congatec has been working closely with processor manufacturers for many years and is a recognized expert in the field of COM development, manufacturing and support. This focus on core competencies significantly reduces development time and costs. ■

# SMPS: a crucial component of systems providing Internet services

By Francesco Di Domenico, Infineon

*The growth of the Internet infrastructure, along with the rising cost of energy and environmental concerns, makes SMPS efficiency optimization across the entire load range a key requirement. This challenging task is combined with the need for higher power densities, which can be achieved only by future significant progress in SMPS technology.*

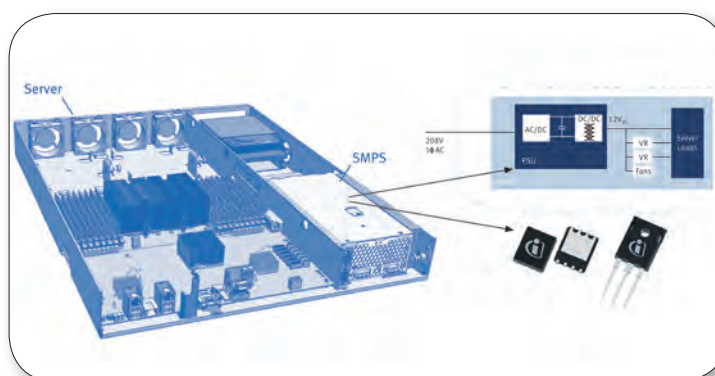

*A modern data center is equipped with a lot of servers, all including an SMPS.*

■ Improving the standard of living requires ever-increasing demand for energy, particularly in electrical forms. People do not directly use electrical energy, but mainly IT and telecommunication equipment, transportation vehicles, white goods, light, mechanical work or media: these are all the tangible effects of electrical energy. Power electronics is the science studying the ways to convert electrical energy into the forms typically used in daily life. A modern power conversion system consists of an energy source, an electrical load, a power electronic circuit, and control functions: the control circuits take information from source and load, determining how the switches must operate to achieve the desired conversion. This is exactly the principle of operation of the SMPS (Switch Mode Power Supply), which uses a high frequency switch (in practice a transistor) with varying duty cycle to maintain regulated output voltage. An AC/DC SMPS is a system consisting of three main stages, as shown in figure 1 in the case of a typical IT server application.

In each of these three stages the role of power or logic components based on semiconductors is fundamental: high voltage power MOSFETs, diode and controllers in the PFC and PWM/resonant stages, low voltage power MOSFETs or diodes in the rectification stage. In fact semiconductors are key com-

ponents in the SMPS evolution, according to the general trends in electronic systems. Actually, the history of power electronics has been closely linked with advances in semiconductor devices. More recently the focus has been moving from a device-driven to an applications-driven scenario, in a system-engineering approach. This transition has been mainly triggered by the fact that advanced semiconductors with suitable power ratings already exist for almost every application of wide interest, so designers show an increasing interest in more flexible, reliable and of course efficient ways to use them.

According to the new system approach, efficiency and power density are definitely more and more in the focus of SMPS design, especially in IT computing applications. Figure 2 shows the most popular efficiency standard followed in this environment, the 80Plus, which fixes the minimum efficiency requirements in typical operating condition (20, 50 and 100% loading). The most recent one, the Titanium, imposes these requirements even at 10% loading, thus at very light load: this is consistent with the operation of modern computing systems, where each power supply is typically used in a paralleled N+1 redundant configuration, so it will work most of the time at loads much closer to 10% than to 100%. In fact in the past the increasing efficiency

need was mainly driven by the capability of heat dissipation at full load without excessive acoustic noise generation by the fan: as a result, maximizing the full load efficiency was more in the focus.

However, more recently the explosive growth of consumer electronics and data processing equipment has led to the introduction of various requirements aimed at the optimization of light-load operation. For example, the workload of Web services can significantly vary based on diurnal cycles, application weights, external events, etc. And this is mostly valid even for high performance computing (HPC) and cloud servers. Meeting this stringent light-load efficiency poses major design challenges to power supply manufacturers, and huge effort has been dedicated by both power semiconductors and control ICs providers to develop technologies able to comply with these specifications, and make the SMPS efficiency plot as flat as possible over the entire load range.

A modern data center looks like an array of racks; in each drawer of it we find a server, and in each server a SMPS can be found therefore a large number of power supplies are expected to be inside such a structure. Looking at the diagram of the power delivery system of a typical large server farm, for each watt consumed



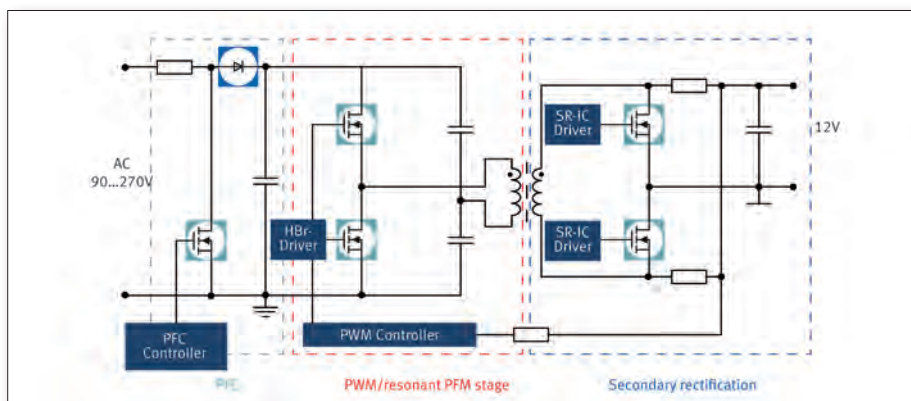

Figure 1. AC/DC SMPS of a typical IT server application

Percent Loading	Standard			Bronze			Silver			Gold			Platinum		
	20%	50%	100%	20%	50%	100%	20%	50%	100%	20%	50%	100%	20%	50%	100%
115 V <sub>rms</sub>	80%	80%	80%	82%	85%	82%	85%	88%	85%	87%	90%	87%	90%	92%	89%
230 V <sub>rms</sub>	-	-	-	81%	85%	81%	85%	89%	85%	88%	92%	88%	90%	94%	91%

Figure 2. The efficiency standard 80Plus

by data processing, more than two watts are wasted in power conversion and cooling. An important parameter used to quantify the server efficiency inside a data center is the so-called Total Cost of Ownership (TCO), defined as the cost to equip and run the servers. In fact, TCO consists of two main components, the CAPEX (capital expenditure, i.e. equipment costs) and the OPEX (operating expenditure, i.e. the energy cost). With steadily decreasing prices of IT equipment, the cost of electricity over the equipment lifetime has become a significant fraction of the initial acquisition cost, especially for low-end equipment such as blade, 1U, and 2U servers (where U is a unit of height measuring 1.75 inches or 4.45 cm), where the cost of power and cooling exceeds the acquisition cost in approximately three years. As a result of the increasing impact of energy cost on the TCO, efficiency considerations have started to have a significant influence on equipment acquisition decisions, starting of course from the SMPS selection. In addition, the increasing

power consumption of IT equipment and in particular that of fast-growing large data center facilities has started to have a serious environmental impact, especially in terms of CO2 emission.

A third important component affecting the TCO is the reliability of components, since repairs can be costly in labor and reserve-capacity provisioning. A similar but maybe less tangible element affecting the TCO is the serviceability of the servers, which involves the time, and therefore the cost of repairs and upgrades. The size and weight of the components, especially the SMPS, may significantly influence this parameter. For this reason the trend in increasing efficiency goes hand in hand with the increasing power density. In figure 3 a short overview of the specific impact on SMPS requirements is displayed.

In fact, SMPSs did not see a dramatic change in power density until the beginning of the rapid growth of the Internet: while a typical



Figure 3. Increasing efficiency goes hand-in-hand with increasing power density.

power density of server front-end power supplies was in the 10 W/in<sup>3</sup> range just 10 years ago, the power density requirement is today in the 40 W/in<sup>3</sup> range. As this trend continues, SMPS with more than 50W/in<sup>3</sup> will be commonly available in few years. These dramatic power density gains have been primarily enabled by the availability of better components (both semiconductors and magnetics), advanced packaging techniques, and also design optimization and consequent new advanced control techniques. An important contribution to the future efficiency and power density is expected to come mostly from system architecture and power management optimization. For this reason, the digital power management bus has been already standardized by the PMBus Consortium. In addition to PMBus compliance, digital control techniques become increasingly popular in power conversion.

Generally, while digital power management can optimize performance at the system level, digital control contributes to optimize the converter-level efficiency in the entire load range by implementing adaptive, load-dependent control algorithms, or phase-shedding in interleaved structures in order to achieve almost flat efficiency plots. In addition, within the digital control, the monitoring, protection, and house-keeping features of power are shifted from hardware to software, which significantly shortens product design time, reduces the cost, and also allows for easy adjustment (“tweaking”) of parameters even during mass production.

Regarding the circuit topologies used inside SMPSs, the opportunity to significantly reduce the size of power converters by increasing the switching frequency created by MOSFET technology has focused topology studies on the reduction of switching losses of the semiconductor devices, which is typically perceived as the major obstacle to maximizing the switching frequency of PWM converters. This has given big emphasis to resonant power conversion, which has led to the development of new families of resonant converters, based on the zero-voltage-switching (ZVS), zero-current-switching (ZCS), quasi-resonant (QR) and multi-resonant concepts. From what has already been mentioned, the role played in SMPS advancement by semiconductor companies like Infineon looks really crucial: power devices, drivers, ICs, analog and digital controllers, everything in the Infineon portfolio, are all fundamental parts of such a system. For this reason, figure 4 shows the typical internal structure of a server AC/DC SMPS and the several families of Infineon components which are used in each of its stages. In fact, the outstanding improvements in SMPS performance achieved in the past 10 years

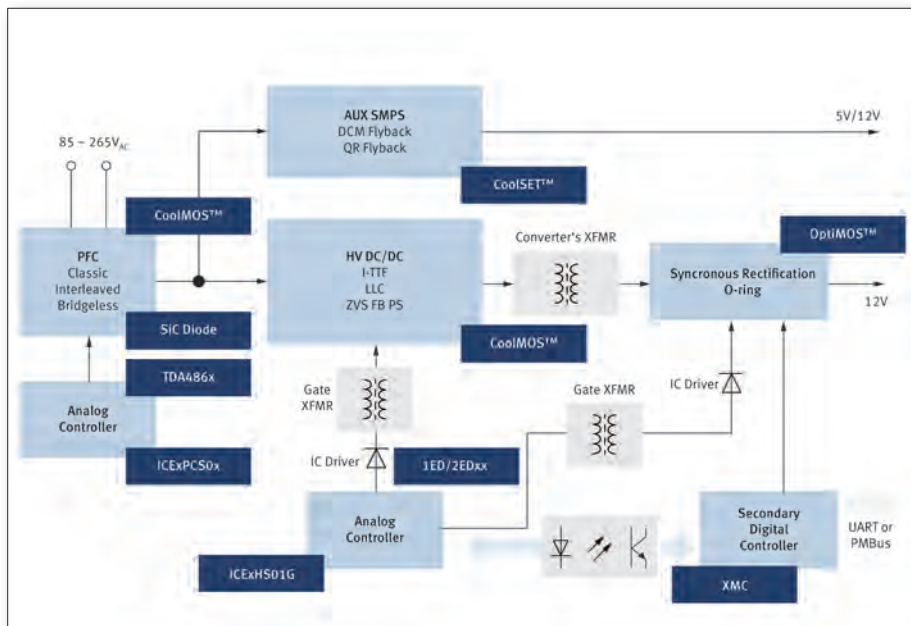

Figure 4. Typical internal structure of a Server AC/DC SMPS and several families of Infineon components which are used in each of its stages.

have been primarily brought by the dramatic reduction of the on-resistance achieved in high-voltage MOSFETs using the revolutionary super junction principle, introduced by Infineon at the end of the nineties in the CoolMOS series, and equally impressive improvements in reverse-recovery characteristics of high voltage SiC (silicon carbide) diodes. In applications with a low output voltage, further efficiency improvements have been made pos-

sible by continuous reduction of on-resistance of low-voltage MOSFETs, like the Infineon OptiMOS series, used as synchronous rectifiers. Introduction of innovative devices based on GaN (gallium nitride) material promises further revolutionary advancements in this field. An important contribution to the progress of SMPS technology comes in particular from the packaging techniques, having the main goal of minimizing parasitics and

improving thermal performances. The need of increased power density has also been triggering more and more advanced component integration: monolithic integration and/or chip co-packaging of semiconductor components such as switches, drivers, and control circuits looks promising in order to shrink the system size. For the same reason the use of magnetics with integrated PCB winding(s), allowing more functional integration, will find more extensive use. Unfortunately, it is commonly recognized that the fast progress in semiconductor technologies has been not followed at the same pace by magnetics and capacitors technology.

The major effort of magnetics manufacturers has been focused on the optimization of the existing materials in certain frequency ranges and expanding the portfolio of core shapes and sizes, in particular low-profile planar cores, which is surely helpful for designers. However, more innovative solutions would be needed in order to further minimize the copper losses due to skin and proximity effects, still considered as the major actual trouble in high-frequency applications. Finally, some progress has been made in the field of low voltage capacitor technology, but no significant changes have been introduced in the high-voltage electrolytic capacitors used as energy-storage (bulk) capacitors: in fact, despite the introduction of some miniaturized series, their typical capacitance/volume ratio is still relatively low. ■

## Product News

### ■ ADI: Blackfin family with up to 800 MMACS and 1 MB of SRAM

Analog Devices introduced the ADSP-BF70x Blackfin processor family, a high-performance DSP series that delivers 800 MMACS of processing power at less than 100 mW. The cost-effective eight-member Blackfin processor family includes up to 1 MB of internal SRAM, eliminating external memory in many applications, while a second configuration features an optional DDR memory interface.

[News ID 1684](#)

### ■ Recom: 4 watt mini power supplies for extreme temperatures

While home electronics operate at relatively comfortable temperatures, the same is not true for many industrial applications. Due to their wide operating temperature range of -40 to +80°C, RECOM's new 4W mini power supplies are well equipped to supply outdoor sensors or control units in residential as well as industrial applications.

[News ID 1803](#)

### ■ EBV launches new website for industrial market

EBV Elektronik is now also offering customers comprehensive online information on all applications, markets and technologies in the industrial segment, such as manufacturing, energy management and transportation. EBV's Industrial website does not only give users an overview of markets and applications, but also offers a wealth of relevant information, from general knowledge to detailed descriptions of applications.

[News ID 1804](#)

### ■ MSC adds nanoRISC processor module with Freescale i.MX6

MSC announces a new nanoRISC embedded processor module which is based on the Freescale i.MX6 System-on-Chip. Different members of the i.MX6 family of ARM Cortex-A9 processors, from single-core to quad-core, will be used for the module resulting in an extremely wide range of usable performance. The MSC nanoRISC-MX6x module can hold up to 4 Gbytes of DDR3 DRAM, up

to 4 Gbytes of SLC NAND Flash and optionally up to 64 Gbytes eMMC Flash.

[News ID 1785](#)

### ■ Silicon Labs: energy-efficient capacitive sensing MCUs for HMIs

Silicon Labs introduced energy-efficient capacitive sensing MCUs for human-machine interfaces. The new C8051F97x MCU family combines Silicon Labs' ultra-low-power technology with capacitive sensing to provide a best-in-class touch control solution for the Internet of Things, home/building automation, consumer and industrial markets.

[News ID 1758](#)

### ■ Mouser: free your sensors with Freescale 9-axis development platform

Mouser Electronics is now shipping the Freescale Freedom Development Platform for Xtrinsic Sensors. This small Arduino compatible Freedom development board is a cost-effective platform for evaluating Freescale's digital gyroscope, accelerometer, magnetometer, and position sensors.

[News ID 1579](#)



## Product News

■ **Maxim: replace 20 discrete chips with one configurable data converter**

Now engineers can mix and match 20 ADCs, 20 DACs or 20 High voltage digital I/O pins in any order using the MAX11300, the new mixed-signal PIXI technology from Maxim. Designers often work with application-specific devices that are neither flexible nor easy to program. The MAX11300 PIXI is the industry's first configurable 20-channel, -10V to +10V high-voltage mixed-signal data converter.

[News ID 1704](#)

■ **Renesas expands development platform for R-IN32M3 SoCs**

Renesas Electronics announced the expansion of its R-IN32M3 series platform solution for industrial Ethernet protocols with an IAR Systems development kit and multiple Industrial Ethernet protocol stacks support. IAR Systems eases device evaluation with the release of its low-cost hardware starter kit, IAR Kick-Start Kit for R-IN32M3 SoCs. The kit includes an R-IN board, an I-jet Lite debug probe and evaluation versions of IAR Embedded Workbench for ARM, as well as lots of pro-

tol stacks on Renesas' website. The solution enables simplified development and contributes to reduced development time for industrial networking applications.

[News ID 1703](#)

■ **Heitec adds color to RiCase table-top and system enclosures**

HEITEC now offers customers the opportunity to get the standardized RiCase table-top and system enclosures family specifically adapted to the customer's corporate design. The chassis itself is not varnished in color, but the color adoption shows in the special finishing of the aluminum corner caps and the plastic decorative elements.

[News ID 1694](#)

■ **Sierra Wireless: cellular connectivity for outdoor lighting fixtures**

Sierra Wireless announced that Philips City-Touch has selected Sierra Wireless AirPrime embedded wireless modules to provide connectivity for the new CityTouch LightWave remote lighting management system. City-Touch LightWave is a new remote lighting

management system that includes intelligent "plug and play" outdoor lighting fixtures. Cities worldwide can roll out the CityTouch system quickly and cheaply, using LED outdoor fixtures that feature built-in mobile connectivity to the central management system, using integrated AirPrime modules.

[News ID 1683](#)

■ **TI: PLC modems to support all three major standards**

Easing the burden of supporting multiple regions with one device, Texas Instruments announced a new power line communication modem platform that supports the G3, PRIME and IEEE-1901.2 standards across both CENELEC and ARIB frequency bands. The new optimized TMDSPCLKITV4 kits provide developers with a smaller low-cost design to evaluate any narrowband orthogonal frequency-division multiplexing PLC technology standard for use in a variety of industrial systems such as smart grid advanced metering infrastructure, solar energy installations, and building and factory automation systems.

[News ID 1676](#)

**ELECTRONIC Meetings MEXICO**

**GUADALAJARA, Mexico**  
October 27-29, 2014

**MANUFACTURING FORUM FOR THE ELECTRONICS INDUSTRY**

**Industrial support:** Continental, hp, IBM

**Organized by:** abe, BCI AEROSPACE

**With support from:** Secretaría de Desarrollo Económico, BIENESTAR MERECES ESTAR BIEN, Jalisco State Gov.

**Institutional support:** CANIETI, index, Cadelec

▶ **Looking to expand your supply chain in Mexico?**  
ONE VENUE: Guadalajara – Mexico  
**Book your agenda on [www.electronic-meetings.com/mexico](http://www.electronic-meetings.com/mexico)**

Taking place at the same time: **AEROSPACE MEETINGS GUADALAJARA Mexico**

# 2014 Yellow Pages



**More** new products  
**More** new technologies  
**More** added every day

[mouser.com](http://mouser.com)



The Newest Products for Your Newest Designs®

## Product Groups

**Real Time Operating Systems**

**Development Tools SW**

**Development Tools HW**

**Embedded Software**

**Embedded Connectivity**

**Micros & DSPs**

**ASSPs & Memories**

**PLDs, ASICs & EDA**

**Analog & Power**

**Embedded Computing**

**SBCs, Busboards & Mezzanines**

**COTS**

**Small Form Factor Boards & COMs**

**Motherboards**

**Industrial Computing**

**Backplanes, Racks & Connectors**

**Data Acquisition**

**Engineering Services**

**Displays**



# Yellow Pages 2014

## The Embedded Companies Directory

This year's edition of our Embedded Companies Directory is split into 2 sections.

The first part provides you with more than 100 short company profiles, including a QR code which leads you to the full company profile (including overview about products & services, contact information, product news,... ) on the [embedded-control-europe.com](http://embedded-control-europe.com) portal.

The second part of the Yellow Pages is a reference list showing in which product categories the companies are active.

### AAEON Technology



AAEON Technology, established in 1992, manufactures and markets a wide range of OEM/ODM Industrial PCs all over the world. AAEON's commitment to the customers is to provide reliable and high quality Fanless Box PCs, Computer on Module (COM Express, XTX, ETX, Q7), Panel PCs, Rugged Tablet Computers, Embedded Computer Boards (5.25', 3.25', Epic, PC/104), Industrial Motherboards (Mini-ITX) and related accessories.



[www.aaeon.eu](http://www.aaeon.eu)

### ADL Embedded Solutions



ADL Embedded Solutions is a leading provider of customizable, embedded solutions for demanding thermal and rugged environments. ADL's diverse portfolio of products range from SBCs based on the AMD Geode™ and Intel® Atom® processors up to 4rd generation Intel® Core™ processors built in PC/104 and 3.5" form factors and full custom design, all of which can be delivered as part of a full system, or individual boards.



[www.adl-europe.com](http://www.adl-europe.com)

### Acromag



Acromag is a multi-million dollar international corporation that combines more than 50 years of process monitoring and control experience with a solid background in high-tech computer design. Established in 1957, Acromag built its reputation designing critical measurement instrumentation equipment. Acromag, Inc. was soon recognized internationally as a leading designer of analog and digital control products for the industrial I/O market.



[www.acromag.com](http://www.acromag.com)

### ADLINK Technology



ADLINK Technology provides a wide range of embedded computing products and services to the test & measurement, automation & process control, gaming, communications, medical, network security, and transportation industries.



[www.adlinktech.com](http://www.adlinktech.com)

### AdaCore



AdaCore provides open source tools and expertise for the development of mission-critical, safety-critical, and security-critical software. AdaCore's flagship products are the GNAT Pro and SPARK Pro development environments and the CodePeer automatic code reviewer and validator. Customers around the world trust GNAT Pro and AdaCore.



[www.adacore.com](http://www.adacore.com)

### Advanced Micro Peripherals



Advanced Micro Peripherals is a leading manufacturer of embedded video solutions - offering the latest MPEG-4 / H.264 (AVC) codecs and video overlay / annotation technologies on a wide range of embedded board form factors including PC/104, PC/104-Plus, PCI/104-Express, CompactPCI and mini PCI modules.



[www.ampltd.com](http://www.ampltd.com)

## ADVANTECH Europe



Founded in 1983, Advantech is a leader in providing trusted, innovative products, services, and solutions. Advantech offers comprehensive system integration, hardware, software, customer-centric design services, embedded systems, automation products, and global logistics support. We cooperate closely with our partners to help provide complete solutions for a wide array of applications across a diverse range of industries.

[www.advantech.eu](http://www.advantech.eu)



## Artesyn Embedded Technologies



Artesyn Embedded Technologies is a global leader in the design and manufacture of highly reliable power conversion and embedded computing solutions for a wide range of industries including communications, computers, healthcare, military, aerospace and industrial automation.

[www.artesyn.com](http://www.artesyn.com)



## ams



ams develops and manufactures high performance analog semiconductors. ams' products are aimed at applications which require extreme precision, accuracy, dynamic range, sensitivity, and ultra-low power consumption. ams' product range includes sensors, sensor interfaces, power management ICs and wireless ICs for customers in the consumer, industrial, medical, mobile communications and automotive markets.

[www.ams.com](http://www.ams.com)



## Artila Electronics



Artila Electronics is founded by professionals with more than 15 years of experience in industrial computer field. Artila focuses on developing easily-accessible, flexibly-programmed industrial ARM-based embedded Linux solutions, including embedded ARM9 Linux single board computers, box computers, system-on-modules, and serial-to-Ethernet embedded modules.

[www.artila.com](http://www.artila.com)



## Apacer



Apacer Technology Inc. was created in 1997 in Taiwan and operates since then as a global leader offering the highest of quality products to satiate the rigorous demands for reliable storage. Apacer Technology provides the most innovative Solid State Drive Solutions (SATA, PATA, Flash Cards & USB SDD) and DRAM Solutions (Desktop, Notebook, Server and Brand Specific) for the industrial and embedded markets.

[www.apacer.com](http://www.apacer.com)



## ASRock



ASRock Inc. is established in 2002, specialized in the field of motherboards. ASRock strives to build up its own brand. With the 3C design concept, "Creativity, Consideration, Cost-effectiveness", the company explores the limit of motherboards manufacturing while paying attention on the eco issue at the same time, developing products with the consideration of eco-friendly concept.

[www.asrock.com](http://www.asrock.com)



## A.R. BAYER DSP Systeme



A.R. Bayer DSP Systeme GmbH was founded in 2003 by Andreas Bayer, a first hour DSP specialist, with a focus on DSP products and services. The company is a spin-off of Bayer DSP Solutions which began operations in 1995. A.R. Bayer DSP Systeme GmbH is an ISO9001-2008 certified company.

[www.dsp-sys.de](http://www.dsp-sys.de)



## Atlantik Elektronik



We scout out the trends on the global markets where technologies are used, and are experts in design-in of innovative semiconductor products. Atlantik Elektronik has a good eye for new developments in technology and anticipates trends while they're still no more than a whisper. We're committed to staying firmly ahead of the rest of the market - and ahead of our time.

[www.atlantikelektronik.de](http://www.atlantikelektronik.de)





## Avalue Technology



Avalue Technology is a professional industrial computer manufacturing company with complete product lines in embedded computers, single board computers, Systems-on-Modules-ETX (SOM-ETX), industrial motherboards, all-purpose Panel/Tablet PCs, and barebone products, etc. Having expanded, Avalue offers its expertise on PCB / Assembly / BIOS version control and after-sales all type of services.



[www.avalue.com.tw](http://www.avalue.com.tw)

## CES - Creative Electronic Systems



CES-Creative Electronic Systems SA, founded in 1981 in Geneva, Switzerland, is a designer and manufacturer of complex high-performance electronic boards, subsystems and complete systems for the embedded computing market, including industrial, automotive, physics, commercial aerospace, defense, telecommunications, medical, as well as other domains requiring advanced technology.



[www.ces.ch](http://www.ces.ch)

## Avent Memec



Avnet Memec, established in 2005, operates on a pan-European basis and employs a significant number of engineers to support customers' design efforts. The company specialised in highly innovative suppliers and technologies, with the goal of helping customers to differentiate their designs. Focusing on a vertical approach, Avnet Memec offers highly specialized solutions to meet the specific requirements of highly differentiated markets.



[www.avnet-memec.eu](http://www.avnet-memec.eu)

## Concurrent Technologies



Concurrent Technologies designs and manufactures a wide range of Single Board Computer products based on Intel® CPU technology for use in critical embedded applications. Designed to be used in both commercial and rugged environments, our products are used by many of the world's leading integrators within the Defence, Security, Aerospace, Telecommunications, Transportation, Medical and Industrial markets.



[www.gocct.com](http://www.gocct.com)

## Axiomtek



Founded in 1990, Axiomtek is one of the major design and manufacturing companies in the Industrial Computer & Embedded field. Since our establishment, Axiomtek has successfully gained worldwide recognition for our innovative designs and outstanding customer satisfaction. Our customers come to us when they want a single, reliable, and valuable source for their industrial computer and embedded platforms.



[www.axiomtek.com](http://www.axiomtek.com)

## congatec



congatec AG has its head office in Deggendorf, Germany and is a leading supplier of industrial computer modules using the standard form factors Qseven, COM Express, XTX and ETX. congatec's products can be used in a variety of industries and applications, such as industrial automation, medical technology, automotive supplies, aerospace and transportation.



[www.congatec.com](http://www.congatec.com)

## bluetechnix



In business since 2004, Bluetechnix is well known for being a manufacturer of high quality embedded systems. We deliver off-the-shelf products for development and integration into customer products as well as tailored solutions including but not limited to firmware and driver development. More than 20 developers continuously expand our broad product and service portfolio.



[www.bluetechnix.com](http://www.bluetechnix.com)

## Data Modul



Data Modul AG offers perfectly tuned Embedded Computer Systems based on ARM, Xscale and x86 architectures. With our partners Congatec, Advantech, Avalue, F&S Elektronik Systeme and Toradex we offer a wide selection of embedded boards with different form factors and performance levels.



[www.data-modul.com](http://www.data-modul.com)

**DAVE**



Embedded systems solutions are DAVE's core business. DAVE designs, produces and sells CPU modules or System-On-Module (SoMs) based on the latest technologies (multi-Core ARM Cortex-A, PowerPC and x86). These products are suitable for the industrial market as well as for medical and home automation applications.



[www.dave.eu](http://www.dave.eu)

**Ecrin Systems**



ECRIN Systems, Leader in embedded computing solutions, designs and manufactures in Europe COTS, MOTS, O.D.M and rugged systems for military/aerospace customers – Government and prime contractors-, OEM, system integrators and application providers in a variety of domains. Our core business is the integration of COTS building blocks based on VPX, Compact PCI, COM Express, Industrial Mother Board, xTCA standard form factors.



[www.ecrin.com/embedded](http://www.ecrin.com/embedded)

**Data Device Corporation (DDC)**



Data Device Corporation (DDC) is the world leader in the design and manufacture of high-reliability data bus products, motion control, and solid-state power controllers for aerospace, defense, and industrial automation applications. For more than 45 years, DDC has continuously advanced the state of high-reliability data communications and control technology for MIL-STD-1553, ARINC 429, Synchro/Resolver interface, and Solid-State Power Controllers.



[www.ddc-web.com](http://www.ddc-web.com)

**E.E.P.D.**



Since its foundation in 1988 E.E.P.D. has grown to become one of the worldwide leading companies for embedded computing solutions. A comprehensive product line, clear migration path, innovative roadmap and overall development strategy has position E.E.P.D. as a recognize leader for Custom, PC/104™, COM Express™ and Single Board Computer solutions.



[www.eepd.de](http://www.eepd.de)

**DFI**



Established in 1981, DFI is a leading supplier of high-performance computing technology worldwide. With more than 29 years of experience, DFI focuses on innovative design and manufacture of leading-edge board and system level products for embedded applications requiring strict revision control and long life availability.



[www.dfi.com](http://www.dfi.com)

**EKF Elektronik**



As an independent systems manufacturer, EKF concentrated, from the very beginning, on complete solutions for industrial problems by using the latest in technology, with a focus on high reliability and long-term availability of all products. In 1998, EKF started development and manufacture of CompactPCI® boards and systems a. In addition, EKF is currently developing solutions for new standards such as CompactPCI® Serial, incorporating the PCI Express® and other high speed technology.



[www.ekf.de](http://www.ekf.de)

**Digi International**



Digi's wireless embedded solutions and services enable device intelligence and connectivity in a broad range of industries, including energy, industrial/building automation and security, medical, retail/POS, office automation, and others. By seamlessly integrating wireless technologies, Digi provides an end-to-end wireless environment for any type of applications and locations.



[www.digi.com](http://www.digi.com)

**ELBACOM Germany**



Elbacom GmbH is a specialised distributor with its core competences in Microsoft Embedded OS, the industrial embedded market and added value services. Elbacom offers developing of customized Embedded Images, Training and support for Embedded Operating Systems and Server Solutions All European Countries are served by Elbacom Local Sales-Companies/Organisations and supported from the Elbacom European Logistic Center in Pamhagen-Austria (ISO certified)



[www.elbacom.com](http://www.elbacom.com)



## Elma



The ELMA group is a global manufacturer of products for housing electronic systems. The company provides everything from components such as modular enclosures, Cabinets and Backplanes up to complete standard or custom System Platforms. ELMA also manufactures precision Rotary Switches. The company offers a fast, flexible response to customer needs and extensive practical knowledge in tailoring solutions to specific applications.

[www.elma.de](http://www.elma.de)



## ept



With our range of connectors and processing technology, we offer you comprehensive all-in-one solutions from a single source. Not only now. As an independent family business with decades of experience, we can offer technical competence and an extremely high quality standard, combined with creativity and precision, when it comes to your individual product and machine solution.

[www.ept.de](http://www.ept.de)



## embedded-logic



Embedded logic develops, and distributes embedded computer boards, ECB manufacture our core authority out are the development and the selling of ECBs. By co-operation with hard and software producers leading world-wide we set yardsticks in flexibility and efficiency. Our success lies in the fast conversion of customer-oriented solutions and our standard products, those covers the entire power spectrum on the PC/104 and ETX market.

[www.embedded-logic.de](http://www.embedded-logic.de)



## ERNI Electronics



ERNI develops and manufactures a wide variety of connectors, backplanes and complete systems, soldering assemblies and Cable Assembly. ERNI is a globally active enterprise with branch offices in Europe, North America and Asia.

[www.erni.com](http://www.erni.com)



## Embedded Office



Embedded Office GmbH & Co. KG founded in 2003 is a specialist company for embedded systems that specializes in safety-critical applications. The company, which is certified to DIN EN ISO 9001 standards, develops and supplies high-tech software for embedded systems as either turn-key solutions or individual components, and, if required, supports the integration at the customer's through to the certification.

[www.embedded-office.com](http://www.embedded-office.com)



## ETAS



ETAS provides innovative solutions for the development of embedded systems for the automotive industry and other sectors of the embedded industry. As a systems provider, ETAS supplies a multifaceted portfolio that covers the range from integrated tools and tool solutions to engineering services, consulting, training, and support.

[www.etas.com](http://www.etas.com)



## emtrion



emtrion, based in Karlsruhe Germany, assists customers during all stages of the development process and integration. From hardware and firmware design, through software development, up to mass production made in Germany. All modules are pin-to-pin compatible, allowing the user to migrate easily between the modules and the longevity of up to 15 years, makes the modules suitable specially for industrial and railway applications.

[www.emtrion.de](http://www.emtrion.de)



## Eurotech



Eurotech is a leading international technology group with headquarters in Italy and facilities throughout Europe, America and Asia. Eurotech is dedicated to the research, development, production and commercialization of miniature computers (NanoPCs) and high performance computing (HPC).

[www.eurotech.com](http://www.eurotech.com)



## EVOCEAN



EVOCEAN GmbH is a successful provider of consulting, coaching, training, and tools for embedded systems. The company focuses on the areas

of Model Driven Development, Requirements Management, Product Line Engineering, and Testing Solutions. EVOCEAN helps its customers to lower development costs while improving time-to-market and quality.



[www.evocean.com](http://www.evocean.com)

## Glyn



GLYN has concentrated its strategic course of business on technical expertise, excellent product support, reliable processes and sophisticated

logistics. A total of 70 technical field sales staff, technical product specialists and application engineers with their important know-how are available to help our satisfied customers.



[www.glyn.de](http://www.glyn.de)

## Express Logic



Express Logic's ThreadX® RTOS is used in over 1.5 billion electronic products, making it one of the most widely used RTOSes in the world. Our

NetX™ TCP/IP stack, USBX™ USB stack, FileX® file system, PEGX™ GUI development kit, TraceX® Graphical event trace, and StackX™ static analysis tool support applications in consumer, medical, industrial, automotive and aerospace applications.



[www.expresslogic.com](http://www.expresslogic.com)

## Green Hills Software



Founded in 1982, Green Hills Software is the largest independent vendor of embedded software solutions spanning from embedded to enterprise.

Green Hills is the only company with an operating system certified and deployed to IEC 61508 SIL 3 (industrial), FDA Class III (medical), EN 51028 SWSIL 4 (railway), EAL6+ High Robustness (security), and DO-178B Level A (avionics).



[www.ghs.com](http://www.ghs.com)

## Freescale



Freescale Semiconductor (NYSE:FSL) is a global leader in embedded processing solutions, providing industry-leading products that are advancing the

automotive, consumer, industrial and networking markets. From microprocessors and microcontrollers to sensors, analog integrated circuits and connectivity – our technologies are the foundation for the innovations that make our world greener, safer, healthier and more connected.



[www.freescale.com](http://www.freescale.com)

## HCC-Embedded



HCC has a unique position in the microcontroller market as a company almost exclusively focused on the development of embedded middle-

ware with no dependence on a proprietary operating system. Specializing in middleware for USB, TCP/IP and Flash storage, the company has become a leader in high value, reusable software components.



[www.hcc-embedded.com](http://www.hcc-embedded.com)

## F & S Elektronik Systeme



F&S Elektronik Systeme GmbH is a leading manufacturer of embedded boards for industrial and medical applications. The company was founded in 1990 as a design office and started with its own products in 1996. All products from F&S are manufactured in-house on our high-precision fully-automated production line.



[www.fs-net.de](http://www.fs-net.de)

## HEITEC



HEITEC AG has represented solution, engineering and industry competence in the fields of software, mechanics and electronics for 30 years. Our

business unit electronics is dedicated to offering electronics system design, electronics manufacturing and electronics packaging solutions. In addition to our expertise and experience in developing complex electronics systems, we are also devoted to manufacturing and packaging these customized solutions.



[www.heitec-electronic.com](http://www.heitec-electronic.com)



## High Tec EDV-Systeme



Founded in 1982, HighTec EDV-Systeme is one of the world leading vendor of embedded software systems. From the time of its release in 1985, the real-time operating system PXROS has found its way into numerous applications including safety-critical applications on the SIL-4 (railway) sector.

[www.hightec-rt.com](http://www.hightec-rt.com)



## ICOP Technology



ICOP Technology, a member of DM&P Group, was started in 1989 as an industrial controller designer and manufacturer. Influenced by the explosive growth of the Industrial computer demand in early 1990, ICOP adopted x86 SoC technology and built their reputation on offering solid embedded Single Board Computer for the applications where small footprint, low power consumption, wide temperature, etc., are concerned.

[www.icoptech.eu](http://www.icoptech.eu)



## Hyperstone



Hyperstone, a fabless semiconductor and microprocessor design company, was founded in 1990 and is based in Konstanz, Germany. Together with subsidiaries in Taiwan, USA and with other worldwide partners, Hyperstone serves a global customer base. Since July 2003, Hyperstone has been a member of the CML Microsystems Plc group.

[www.hyperstone.com](http://www.hyperstone.com)



## IEI Integration



IEI Integration Corp., was founded in 2005, is one of the world's leading industrial computer providers. IEI has gained the reputation of being fully customer orientation from every aspect, including technology research, product design and development, flexible production, marketing, sales and customer service.

[www.ieiworld.com](http://www.ieiworld.com)



## IAR Systems



IAR Systems provides developers of embedded systems with world-leading software tools for developing competitive products based on 8-, 16-, and 32-bit processors. Established in Sweden in 1983, the company has over 46 000 customers globally, mainly in the areas of industrial automation, medical devices, consumer electronics, telecommunication, and automotive products.

[www.iar.com](http://www.iar.com)



## ies Industrie-Elektronik



The company ies develops, manufactures and markets electronic systems and their components for industrial applications since 1966. With a well-established team of 35 experienced employees, we are an ideal partner for the development, production and maintenance of customer-specific electronic products for our customers.

[www.ies-gmbh.de](http://www.ies-gmbh.de)



## iBASE



Founded in 2000, iBASE Technology is an ISO 9001, ISO 13485 and ISO 14001 certified company that specializes in the design and manufacturing of industrial PC products. iBASE provides OEM/ODM services tailoring products to customers' requirements. Current product offerings from iBASE include single board computers, Mini-ITX boards, Disk-Size SBC, COM Express CPU modules, embedded systems, panel computers and network appliance for various.

[www.ibase.com.tw](http://www.ibase.com.tw)



## IMACS



We have been developing and producing instrumentation, control and automation systems for various industries since 1991. Whether it is single components or complete embedded systems, our solutions are always individual and flexible. We employ a total of 30 staff at our two locations. Our head office and centre for administrative and development activities is situated at Kornwestheim, near Stuttgart, Germany.

[www.imacs-gmbh.de](http://www.imacs-gmbh.de)



## IMCOR



IMCOR GmbH, based near Stuttgart, Germany was founded in 1993 as a system and software house for IT-applications in industrial areas. IMCOR offers development and test tools focused on software developers and embedded systems engineers.

[www.imcor.de](http://www.imcor.de)



## IST Group



The IST Group is a German based, international acting technology group. For more than 15 years we have been developing complex electronic board-level and system-level solutions for world-leading companies.

[www.istgroup.de/en](http://www.istgroup.de/en)



## Incostartec



The company INCOSTartec GmbH was founded by renaming in November 1999 from the innovative engineering company Gerhard Schink. Since 1994 we have been on the market of embedded computer technology field. We develop and produce single-board computer(SBC), Embedded Systems, Panel PC and its peripherals for industrial use.

[www.incostartec.com](http://www.incostartec.com)



## iSYSTEM



iSYSTEM is a privately held company founded in 1986, with offices in Munich, Germany and Ljubljana, Slovenia. We maintain decades-long relationships with highly skilled distributors in major world markets. iSYSTEM specializes in embedded development and test tools especially for markets where functional safety and the appropriate standards do play a major role.

[www.isystem.com](http://www.isystem.com)



## Infineon Technologies



Infineon Technologies AG, Neubiberg, Germany, offers innovative semiconductor and system solutions addressing three central challenges to modern society: energy efficiency, mobility, and security.

[www.infineon.com](http://www.infineon.com)



## Jactron



Jactron - experienced UK distributor specialising in NAND flash storage solutions and DRAM module technology designed for applications that demand the very highest level of reliability and endurance. Jactron's mission is to provide the highest level of quality, reliability and support to the storage industry, ensuring all of our customers find the right storage solutions to suit their applications.

[www.jactron.co.uk](http://www.jactron.co.uk)



## IS2T



IS2T offers software development solutions for embedded systems. Our comprehensive product portfolio delivers unified solutions to design applications for a wide range of hardware platforms including flash-based microcontrollers from major semiconductor vendors and microprocessors running various operating systems such as Linux, iOS, Android.

[www.is2t.com](http://www.is2t.com)



## Kithara Software



Kithara Software is a specialist for RealTime on Windows operating systems with more than 15 years of experience. With our comprehensive know-how and many years of expertise we will help you to realize even challenging projects.

[www.kithara.de](http://www.kithara.de)





## Kontron



Kontron is a global leader in embedded computing technology. With more than 40% of its employees in Research and Development, Kontron creates many of the standards that drive the world's embedded computing platforms. Kontron's product longevity, local engineering and support, and value-added services, helps create a sustainable and viable embedded solution for OEMs and system integrators.



[www.kontron.com](http://www.kontron.com)

## MathWorks



MathWorks is the leading developer of mathematical computing software. MATLAB®, the language of technical computing, is a programming environment for algorithm development, data analysis, visualization, and numeric computation. Simulink® is a graphical environment for simulation and Model-Based Design of multidomain dynamic and embedded systems.



[www.mathworks.com](http://www.mathworks.com)

## Lauterbach



Lauterbach is the leading manufacturer of complete, modular microprocessor development tools world wide with 30 years experience in the field of embedded designs. Lauterbach is an internationally well-established company with blue chip customers from every corner of the globe and close relationship with all semiconductor manufacturers.



[www.lauterbach.com](http://www.lauterbach.com)

## Maxim Integrated



Maxim Integrated designs, manufactures, and sells high-performance semiconductor products. The company was founded 30 years ago with the mission to deliver innovative analog and mixed-signal engineering solutions for the industrial, communications, consumer, and computing markets.



[www.maximintegrated.com](http://www.maximintegrated.com)

## LDRA



For more than forty years, LDRA has developed and driven the market for software that automates code analysis and software testing for safety-, mission-, security- and business-critical markets. Boasting a worldwide presence, LDRA is headquartered in the UK with subsidiaries in the United States, India and an extensive distributor network. For more information on the LDRA tool suite.



[www.ldra.com](http://www.ldra.com)

## MEN Mikro Elektronik



Since its founding in 1982 – and with more than 250 employees worldwide – MEN Mikro Elektronik has focused on innovation, reliability and flexibility to develop and produce standard and custom computing solutions that employ the highest technology levels. The company provides a robust offering of highly reliable embedded COTS boards and devices widely used in extreme environmental conditions found in industrial and safety-critical applications.



[www.men.de](http://www.men.de)

## LieberLieber Software



LieberLieber Software GmbH is an internationally operating company and solution partner of Sparx Systems, specialising in EA add-ins and customizations for innovative companies in the sectors: automotive, aerospace and defence, medical equipment, mechanical engineering, embedded systems and software development.



[www.lieberlieber.com](http://www.lieberlieber.com)

## Micrium



Micrium is a global RTOS leader and a top choice of embedded engineers building microprocessor, microcontroller and DSP-based devices. Our commercial RTOS components are the preferred solution over open source and competitive alternatives. The company's flagship µC/OS family is recognized for unparalleled reliability, performance, dependability, impeccable source code, and extensive documentation.



[www.micrium.com](http://www.micrium.com)

### Micron



For more than 30 years, Micron have redefined innovation—designing and building some of the world’s most advanced memory and semiconductor technologies. Our roots are in memory, the core strength of our business. As we look toward the future, we’ll continue to build on our past achievements by leveraging the synergies between our core memory business and diversified products and technologies.

[www.micron.com](http://www.micron.com)



### MSI (Micro-Star International)



MSI (Micro-Star International), a world-class manufacturer of an extensive variety of the highest quality IT products, is one of Taiwan’s top 3 leading motherboard manufacturers and one of the top five front-end server manufacturers in the world. MSI was founded in 1986 and has over-20-year experience in motherboard manufacturing.

[www.msi.com/lipc](http://www.msi.com/lipc)



### Microsemi



Microsemi Corporation offers a comprehensive portfolio of semiconductor and system solutions for communications, defense & security, aerospace and industrial markets. Products include amongst others high-performance, radiation-hardened and highly reliable analog mixed-signal integrated circuits, FPGAs, SoCs and ASICs.

[www.microsemi.com](http://www.microsemi.com)



### MicroSys Electronics



MicroSys Electronics GmbH located in Sauerlach close to Munich, designs and develops embedded system solutions, for e.g. VMEbus, CompactPCI and other common bus infrastructures. From the beginning in 1975, customized solutions offering longevity are a strong part of MicroSys business as well. Successfully deployed products span from Computer on Modules up to fully integrated systems.

[www.microsys.de](http://www.microsys.de)



### Mouser Electronics



Catering to design engineers and buyers demanding small to medium quantities of the latest products, Mouser requires no MOQ and fills orders by breaking packs, including one-piece shipping. This is especially attractive to engineers working in the earliest stages of the prototype design cycle. Mouser is dedicated to providing superior service and support to customers worldwide with 20 global customer support centres.

[www.mouser.com](http://www.mouser.com)



### N.A.T.



N.A.T. is the expert in turnkey systems and high performance connectivity products for data and (tele-)communication solutions. The product portfolio is dedicated to embedded markets such as medical, energy, communication, defense&aerospace, industrial controls, automation, transportation, test&measurement, and research.

[www.nateurope.com](http://www.nateurope.com)



### MSC Technologies



The brand of MSC Technologies covers three distinct areas of activity, Display Solutions, Embedded Solutions and Distribution. The Display Solutions group offers a large portfolio of diverse display technologies. Embedded Solutions are more than just products. MSC offers all services from the idea to the final product. In Distribution, MSC represents well-known manufacturers in wireless, memory/storage, power and LED components.

[www.msc-technologies.eu](http://www.msc-technologies.eu)



### Nexcom Europe



Founded in 1992, NEXCOM International Co. Ltd. has successfully emerged as a market leader in the fields of industrial and embedded computing, network security appliances, and blade servers. With the employment of IT professionals specializing in the areas of ASIC design, multi-processor architecture, graphic workstation development, and reliability engineering, NEXCOM has rapidly grown from its small beginning into a highly reputable company.

[www.nexcom.eu](http://www.nexcom.eu)





## Phaedrus Systems



Phaedrus Systems supports engineers at all stages of embedded development. We specialise in support for safety-critical and high-integrity projects. A portfolio of tools to provide all the elements required to create an integrated tool chain - from initial specification through to life cycle management – has been assembled specifically for this demanding area of engineering.



[www.phaedsys.com](http://www.phaedsys.com)

## powerBridge



powerBridge Computer markets computer boards, systems and displays for applications in telecommunication, industrial automation, medical, transportation, defence, and aerospace. We design and integrate computer systems based on standard components and manufacture systems according to customer specification. Experienced engineers advise and support our customers. Continuity and reliability are our strength.



[www.powerbridge.de](http://www.powerbridge.de)

## PEAK-System Technik



Founded in 1999, PEAK-System Technik is a leading provider of hardware, software, and services for the industrial communication. The focus is on the field busses CAN and LIN.



[www.peak-system.com](http://www.peak-system.com)

## PragmaDev



PragmaDev is a privately held company based in Paris France that provides a set of modeling and testing tools for the development of real time and embedded software: „Real Time Developer Studio“ and „PragmaDev Tracer“.



[www.pragmadev.com](http://www.pragmadev.com)

## PLUG-IN Electronic



The company PLUG-IN Electronic GmbH based in Eichenau near Munich, Germany, has been marketing hardware and software for PC-assisted measuring and automation technology since being founded in December 1990. The core business focuses mainly on hardware solutions, with software solutions only being offered on the basis of graphic programming environments.



[www.plug-in.de](http://www.plug-in.de)

## PRQA



For more than 25 years, PRQA has been the leader in defect prevention. Our solutions, designed to work hand-in-hand with developers, promote safe coding practices and proactively ensure the highest quality code for safety-critical and mission-critical systems.



[www.programmingresearch.com](http://www.programmingresearch.com)

## PLS



PLS is among the worldwide leading suppliers of debugging solutions and complete development tools for 16-bit and 32-bit microcontrollers and System-on-Chips (SoC). Important architectures such as TriCore, Power Architecture, RH850, ARM, Cortex, XC2000/XE166, SH-2A, XScale and C166/ST10 as well as simulation platforms of different vendors are supported.



[www.pls-mc.com](http://www.pls-mc.com)

## Renesas Electronics



Renesas Electronics is the world's number one supplier of microcontrollers and a premier supplier of advanced semiconductor solutions, including system-on-chip and a wide range of discrete analogue and power devices. Established in 2010, Renesas Electronics combines the collective semiconductor expertise of Hitachi, Mitsubishi Electric and NEC Electronics, encapsulating more than 350 years' experience.



[www.renesas.eu](http://www.renesas.eu)

## RistanCASE



Founded in 1993, located in Walisellen-Zurich, Switzerland. RistanCASE develops and markets software development tools for programming embedded applications using micro-controllers.



[www.ristancase.com](http://www.ristancase.com)

## SEGGER



SEGGER Microcontroller develops and distributes hardware and software development tools as well as software components for embedded systems. SEGGER's intention is to cut software development time for embedded applications by offering affordable, high quality, flexible and easy-to-use tools and software components allowing developers to focus on their applications.



[www.segger.com](http://www.segger.com)

## Rohde & Schwarz



For nearly 80 years, Rohde & Schwarz has stood for quality, precision and innovation in all fields of wireless communications. The company is strategically based on four pillars: test and measurement, broadcasting, secure communications, radiomonitoring and radiolocation.



[www.rohde-schwarz.com](http://www.rohde-schwarz.com)

## Sierra Wireless



Sierra Wireless is the global leader in machine-to-machine (M2M) devices and cloud services. We offer the industry's most comprehensive portfolio of 2G, 3G and 4G embedded modules and gateways, seamlessly integrated with our secure M2M cloud services. Sierra Wireless has more than 850 employees globally and has R&D centers in North America, Europe and Asia.



[www.sierrawireless.com](http://www.sierrawireless.com)

## SCIOPTA Systems



SCIOPTA is a leader in system software for safety-critical embedded applications. This includes real-time operating systems, network software, file systems, software for interface bus systems, board support packages and other system software.



[www.sciopta.com](http://www.sciopta.com)

## SYSGO



Since 1992, SYSGO provides operating systems and services for embedded systems. In the late 90's, the company pioneered the use of Linux in the embedded field with its embedded Linux distribution ELinOS. To meet the growing needs for functional safety and IT security in complex applications, SYSGO introduced PikeOS, the world's first SIL4 certified hypervisor for multi-core processors. Today, it builds the foundation for smart devices in the Internet-of-Things.



[www.sysgo.com](http://www.sysgo.com)

## SECO



SECO, is a world-leading company in electronic embedded solutions. Spanning its 30+ years of experience, SECO has shown the ability to adapt its know-how to new, challenging customers' needs, and to provide cutting edge solutions to its partners. On the strength of its know-how and in contrast with recent outsourcing trends, SECO has always set the entire production cycle in Italy, from the development stage to mass distribution.



[www.seco.com](http://www.seco.com)

## Syslogic



Syslogic supplies industrial computers embedded PCs, single board computers and touch panel computers for demanding industrial use. These are used in areas such as machining and automotive engineering as well as traffic and train technology. Syslogic is one of the few companies in the embedded branch that develops and assembles all of its embedded computers and touch panel computers itself.



[www.syslogic.com](http://www.syslogic.com)



## Telit



With over 12 years dedicated to the m2m market, Telit has a network of eight R&D centers around the globe. Telit continues to demonstrate a unique ability to translate prowess in the various technologies it dominates, into business breakthroughs. Telit's portfolio of the highest quality cellular, short-range, and global navigation satellite system (GNSS) modules; all available in over 80 countries from 35 sales offices and 60 distributors.



[www.telit.com](http://www.telit.com)

## Trinamic



Based in Hamburg, Germany, TRINAMIC provides integrated Circuits and Modules for Motor and Motion Control to customers all over the world, most of them leaders in their Industry.



[www.trinamic.com](http://www.trinamic.com)

## Tenasys



Using our knowledge of PC platforms and RTOS, we've developed industry-leading embedded virtualization technology to produce advanced embedded virtualization software solutions for real-time, mission-critical control applications for PC platforms. These solutions enable you to create multi-core/multi-platform RTOS solutions coupled to Windows, INtime® for Windows®, or as a standalone version, INtime® Distributed RTOS.



[www.tenasys.com](http://www.tenasys.com)

## Vecow



Vecow has been devoted to designing and developing high quality products with innovative technology since it was founded. Our application fields of industrial automation, high-speed data acquisition, motion control, medical and home automation and video surveillance are credited to Vecow high-efficient design service.



[www.vecow.com](http://www.vecow.com)

## Texas Instruments



Texas Instruments develops analog, digital signal processing, RF and DLP® semiconductor technologies that help customers deliver consumer and industrial electronics products with greater performance, increased power efficiency,



[www.ti.com](http://www.ti.com)

## WIBU-SYSTEMS



WIBU-SYSTEMS AG is a technology leader in the global software licensing market. In its mission to deliver unique, most secure and highly flexible technologies to software publishers and industrial manufacturers, Wibu-Systems has developed a comprehensive, award-winning suite of hardware- and software-based solutions incorporating internationally patented processes dedicated to the integrity protection of digital assets and intellectual property.



[www.wibu.com](http://www.wibu.com)

## TQ-Group



Based on technologically sophisticated designs, TQ-Group provides highly-integrated, Embedded Systems, such as: Minimodules, Mainboards, Evaluation boards, Ready-to-use industrial systems and Customer specific solutions. Modular designs save time and money. In many industrial sectors, the use of modular devices is key to efficiency.



[www.tq-group.com](http://www.tq-group.com)

## Wind River



Wind River, a wholly owned subsidiary of Intel Corporation (NASDAQ: INTC), is a world leader in embedded and mobile software. Wind River has been pioneering computing inside embedded devices since 1981 and its technology is found in more than 1 billion products.



[www.windriver.com](http://www.windriver.com)

## WynMax



For the 25 years past, WynMax founders have set up several well-known IPC manufacturers with records. For market's emerging new demands for services and expertise, the founders have decided to build one and only best IPC ever, WynMax; it is not for himself or herself, but for the customers and new talented staff. With that philosophy embedded, in 2006, WynMax is established on the humble service for sales and marketing.

[www.wynmax.com.tw](http://www.wynmax.com.tw)



## Xilinx



Today, Xilinx is the world's leading provider of programmable platforms, with \$2.4B in revenues in fiscal year 2011 and nearly 50 percent market share. The programmable logic device (PLD) market - one of the fastest growing segments of the semiconductor industry - grew by 48 percent in 2010 to \$4.9B USD and is projected to double from 2009 levels to \$6.6B USD by 2013 (Source: IC Insights).

[www.xilinx.com](http://www.xilinx.com)



## XiSys Software



XiSys Software GmbH is a provider of innovative and leading edge Software Tools and Development Environments for Graphical User Interfaces (GUIs). The products are dedicated to highly embedded, reliable system solutions with typically long product lifecycles of up to 10 years and more. The company was founded in 1994 and supports with its XiBase9 product line, operating systems like Linux, Microsoft® Windows® or RadiSys Microware® OS-9.

[www.xisys.de](http://www.xisys.de)



boards & solutions + ECE



**FREE SUBSCRIPTION to Boards & Solutions / ECE Magazine**  
The European Embedded Systems Design Magazine

Technical Articles and Product News about:

- Embedded Computing (Boards, Modules, Systems, Software, Services)
- Chip-level Hardware (Microcontrollers, ASSPs, Analog & Power Management, FPGAs)
- Tools & Software

[www.embedded-control-europe.com/magazine](http://www.embedded-control-europe.com/magazine)





# ■ YELLOW PAGES 2014 - PRODUCT GROUPS REFERENCE LIST

company	Real Time Operating Systems	Development Tools SW	Development Tools HW	Embedded Software	Embedded Connectivity	Micros & DSPs	ASSPs & Memories	PLDs, ASICs & EDA	Analog & Power	Embedded Computing	SBCs, Busboards & Mezzanines	COTS	Small Form Factor Boards & COMs	Motherboards	Industrial Computing	Backplanes, Racks & Connectors	Data Acquisition	Engineering Services	Displays
A.R. BAYER DSP Systeme	•	•	•	•		•				•	•						•	•	
AAEON Technology	•			•	•					•	•	•	•	•	•	•		•	
Acromag					•					•	•	•	•		•		•		
AdaCore		•		•						•		•						•	
ADL Embedded Solutions	•									•	•	•	•	•	•			•	
ADLINK Technology					•						•	•	•	•	•	•	•		
Advanced Micro Peripherals										•	•	•	•		•			•	
Advantech	•			•	•					•	•	•	•	•	•	•	•		
ams					•		•	•	•									•	
Apacer						•	•			•		•		•	•				
Artesyn Embedded Technologies				•	•				•	•	•	•	•	•	•			•	
Artila Electronics	•	•	•	•	•				•	•	•		•		•		•	•	
ASRock										•	•		•	•	•				
Atlantik Elektronik						•	•	•	•										
Avalue Technology	•		•	•						•	•			•	•	•		•	
AVNET Memec		•	•	•	•	•	•	•	•	•					•		•		
Axiomtek										•	•		•	•	•	•	•	•	
bluetechnix	•	•	•	•	•	•			•	•	•	•	•	•	•	•	•	•	
CES - Creative Electronic Systems										•	•	•	•	•	•				
Concurrent Technologies										•	•	•			•				
congatec			•	•						•	•				•			•	
Data Device Corporation (DDC)									•	•	•	•	•		•		•		
Data Modul			•							•	•		•	•	•				•
DAVE						•				•	•		•	•	•		•	•	
DFI					•					•	•	•	•	•	•	•		•	
Digi International	•	•	•	•	•	•	•	•	•	•	•	•	•	•	•	•	•	•	
E.E.P.D.										•	•		•		•			•	
Ecrin Systems										•	•	•	•	•	•			•	•
EKF Elektronik										•	•				•	•		•	
Elbacom	•	•		•						•								•	
Elma Electronic										•	•				•	•		•	
Embedded Office	•	•		•	•														

company	Real Time Operating Systems	Development Tools SW	Development Tools HW	Embedded Software	Embedded Connectivity	Micros & DSPs	ASSPs & Memories	PLDs, ASICs & EDA	Analog & Power	Embedded Computing	SBCs, Busboards & Mezzanines	COTS	Small Form Factor Boards & COMs	Motherboards	Industrial Computing	Backplanes, Racks & Connectors	Data Acquisition	Engineering Services	Displays
embedded-logic										•	•		•	•	•			•	
emtrion	•			•	•					•	•		•	•	•			•	
ept										•			•		•	•		•	
ERNI											•					•		•	
ETAS	•	•	•	•													•	•	
Eurotech			•		•					•	•	•	•		•	•		•	
EVOCEAN	•			•														•	
Express Logic	•	•	•	•	•														
F & S Elektronik Systeme	•			•						•	•		•	•	•			•	
Freescale		•	•		•	•			•										
Glyn	•	•	•			•	•	•		•									•
Green Hills Software	•	•	•	•	•													•	
HCC-Embedded		•		•														•	
Heitec	•			•						•		•			•	•		•	
High Tec EDV-Systeme	•	•	•	•														•	
Hyperstone					•	•	•	•											
IAR Systems		•	•	•	•													•	
iBASE					•					•	•			•	•	•			•
ICOP Technology	•		•		•					•	•	•	•	•	•	•	•	•	•
IEI	•	•	•	•	•					•	•		•	•	•	•	•	•	•
ies Industrie-Elektronik										•	•	•	•	•	•	•		•	
IMACS		•		•	•					•							•	•	
IMCOR	•	•	•	•	•					•							•		
INCOstartec										•	•		•	•		•	•	•	
Infineon		•	•			•	•	•	•										
IS2T	•	•	•	•	•													•	
IST Group										•	•		•		•			•	
iSYSTEM	•	•	•	•	•					•					•		•	•	
Jactron			•		•	•	•	•	•	•	•	•	•	•	•		•	•	
Kithara Software	•	•		•	•										•				
Kontron	•	•	•	•	•					•	•	•	•	•	•	•	•	•	
Lauterbach	•	•	•	•	•					•								•	
LDRA		•		•													•		
LieberLieber Software	•		•	•						•								•	
MathWorks		•		•						•					•		•	•	
Maxim Integrated					•	•	•	•	•										



## ■ YELLOW PAGES 2014 - PRODUCT GROUPS REFERENCE LIST

company	Real Time Operating Systems	Development Tools SW	Development Tools HW	Embedded Software	Embedded Connectivity	Micros & DSPs	ASSPs & Memories	PLDs, ASICs & EDA	Analog & Power	Embedded Computing	SBCs, Busboards & Mezzanines	COTS	Small Form Factor Boards & COMs	Motherboards	Industrial Computing	Backplanes, Racks & Connectors	Data Acquisition	Engineering Services	Displays
MEN Mikro Elektronik	•									•	•	•	•	•	•	•	•	•	•
Micrium	•	•		•	•	•				•		•							
Micron					•	•	•			•					•				
Microsemi					•	•	•	•	•			•							
MicroSys		•	•							•	•	•	•		•	•		•	
Mouser Electronics		•	•	•	•	•	•	•	•	•	•					•	•		
MSC Technologies	•	•	•	•		•	•	•	•	•	•		•			•	•	•	•
MSI (Micro-Star International)										•	•		•	•	•				
N.A.T. GmbH	•			•						•	•	•		•	•		•	•	
Nexcom Europe										•	•		•	•	•			•	
PEAK-System Technik		•	•	•													•	•	
Phaedrus	•	•	•	•														•	
PLS	•	•	•	•														•	
PLUG-IN Electronic					•					•	•			•	•	•	•	•	•
powerBridge										•	•	•	•	•	•	•	•	•	
PragmaDev	•	•	•	•															
PRQA		•		•														•	
Renesas		•	•		•	•	•	•	•										
RistanCASE		•	•	•															
Rohde & Schwarz		•															•	•	
SCIOPTA Systems	•	•		•	•													•	
SECO			•	•	•					•	•	•	•	•	•			•	
SEGGGER	•	•	•	•	•					•					•				
Sierra Wireless					•	•	•		•										
SYSGO	•	•		•	•					•		•			•			•	
Syslogic	•				•					•	•		•		•		•	•	•
Telit				•	•					•					•			•	
TenAsys	•		•	•	•					•								•	
Texas Instruments		•	•	•	•	•	•	•	•										
TQ Systems	•		•	•						•	•		•	•	•			•	
Trinamic		•	•	•			•		•	•			•					•	
Vecow					•					•			•		•				
WIBU-SYSTEMS	•	•	•	•	•					•					•			•	
Wind River	•	•	•	•	•					•		•						•	
WynMax	•		•		•					•	•		•	•	•			•	•
Xilinx		•	•	•	•			•											
XiSys Software	•	•		•						•					•			•	

■ **Bayer DSP Systeme: ARM and DSP based SOMs from Critical Link**

Systems-on-Modules from Critical Link are now available in Central Europe through A.R. Bayer DSP Systeme. These small, highly integrated modules combine fast processors (ARM or DSP) with a powerful FPGA for a maximum of performance and flexibility. MityDSP and MitySOM System on Modules are building blocks, serving as the foundation for your custom electronic design. The SoMs have a long lifetime and come with the tools and the support needed to ensure your product success.

[News ID 1627](#)

■ **Telit: GateTel adds m2mAIR mobile connectivity to its M2M solutions**

Telit Wireless Solutions announced that long-time, exclusive client GateTel has added m2mAIR Mobile connectivity and value-added services to its offering of xE910 module-based terminals and gateways. m2mAIR Mobile is the Telit service group dedicated to mobile network connectivity. It includes resources for business and operations in support of m2m application deployment in the mobile network environment.

[News ID 1685](#)

■ **MSC: COM Express Type 6 modules with Celeron CPUs**

MSC has expanded its MSC C6B-8S COM Express Type 6 module family based on fourth generation Intel Core processors with two cost-efficient Celeron variants. The powerful computer-on-modules are suitable for sophisticated applications in imaging, medical, digital signage and gaming systems. The new high-end modules integrate the 2000E (2.2GHz) or 2002E (1.5GHz) Intel Celeron processors with two CPU cores and 2MB cache.

[News ID 1624](#)

■ **AAEON: new embedded boards with Celeron J1900, N2930, N2807 and Atom E3800 series**

AAEON released products based on the new Intel Celeron J1900, N2930, N2807 and Atom E3800 series processors. The AAEON GENE-BT05 is a 3.5" board that despite being based on the new Intel Celeron and Atom series platform still offers support for legacy LVDS panels in addition to the more common HDMI and VGA standards. It offers a highly competitive I/O interface, with four USB ports, one SATA port, four serial ports and two Ethernet ports.

[News ID 1614](#)

■ **Advantech: solution for intelligent vending based on Intel reference design**

Advantech released a new solution with the Intel Reference Design for Intelligent Vending. Advantech delivers the Vending Machine Controller functionality to a PC-based computing platform with a Vending Machine IO board. PC based computing platform makes vending machines intelligent, allowing enhanced user experience with LCD and touchscreen interface, telemetry, proximity marketing, advertising and data analytics (real time promotion, pricing update, i.e.) using data coming from the cloud.

[News ID 1612](#)

■ **DDC: multi-protocol data bus networking XMC and PMC cards**

Data Device Corporation introduces new Multi-Protocol Data Bus Networking XMC and PMC cards capable of supporting all avionic I/O requirements. The card's high channel mix enables this single, compact solution to replace several individual I/O cards providing significant Size, Weight, Power and Cost savings.

[News ID 1611](#)

■ **Amplicon: fanless embedded PC with multiple PCIe expansion**

The Amplicon Impact-E 300 builds upon the strong foundations of the Impact-E 200, offering reliability, monitored life cycle and road mapped components. Packaged in a light-weight chassis designed for optimal heat dissipation, the Impact-E 300 is a powerful embedded system with full OEM branding options available for the chassis and operating system; resulting in a professional branded unit. The Impact-E 300 is the latest addition to the Amplicon Impact-E series to deliver the power of the Ivy bridge mobile iCore processor and amazing feature set of the Intel QM77, all packaged in a fanless compact chassis with options for expansion.

[News ID 1572](#)

■ **ADLINK: Gemalto solution to accelerate deployment of cloud-based M2M services**

ADLINK is utilizing machine-to-machine software as a service solution from Gemalto, to provide remote system monitoring and real-time maintenance for connected devices. ADLINK embedded systems are used to manage and control business processes and assets such as medical and industrial automation equipment, digital signage, communications infrastructure, and transportation networks.

[News ID 1568](#)

■ **DDC: light weight synchro booster amplifier for shipboard applications**

Data Device Corporation introduces a light and small form factor Synchro Booster Amplifier for shipboard applications. The SBA-3500X is the latest product offering in DDC's expanding portfolio of motion feedback solutions for the defense and aerospace markets.

[News ID 1563](#)

■ **DATA MODUL: Qseven module based on Atom E3800 processor family**

With the conga-QA3 DATA MODUL presents a new generation of Qseven modules from their partner congatec. The conga-QA3 provides twice the performance over its predecessor plus an optimized product lifespan thanks to development with ceramic condensators. It comes in five different Intel Atom processor-based versions ranging from entry-level single-core Intel Atom processor E3815 with 1.46 GHz and a low power consumption of 5 watts, up to the quad-core Intel Atom processor E3845 with 1.91 GHz and 10 watts.

[News ID 1552](#)

■ **Microsemi: new SmartFusion2 SoC FPGA Evaluation Kit**

Microsemi announces the availability of the company's new SmartFusion2 SoC FPGA Evaluation Kit. The SmartFusion2 Evaluation Kit allows for simplified development of transceiver I/O-based FPGA designs necessary in today's PCI Express and Gigabit Ethernet-based systems. For faster evaluation and prototyping, Microsemi's leading-edge evaluation board is small form-factor PCIe compliant, which can be used on any desktop PC or laptop with a PCIe slot.

[News ID 1802](#)

■ **PragmaDev: testing and model simulation are top upcoming topics**

PragmaDev latest survey indicates testing and model simulation are the top upcoming topics. The survey also confirmed last year's results indicating a substantial decrease in UML usage forecast. For the first time in the study the effective usage of UML has been slightly decreasing from 71% in 2013 to 70% this year. The survey also confirms UML and SysML models are mainly used for documentation, where Matlab and SDL models are mainly used for simulation and code generation. The on-line survey took place between January and May 2014 and gathered 84 responses, most of them out of PragmaDev's existing contacts.

[News ID 1772](#)

**M**ore information about each news is available on [www.Embedded-Control-Europe.com/magazine](http://www.Embedded-Control-Europe.com/magazine)  
You just have to type in the "News ID". —

### ■ **ADLINK: waterproof industrial mobile computer featuring Android 4.0 OS**

ADLINK releases the IMX-3000 industrial mobile computer, a clear choice for a variety of industrial applications, featuring the Android 4.0 operating system and a compact housing for easy transport. Near Field Communication, a barcode scanner and 3G/WLAN wireless communication capability improve real-time information delivery and fulfill a host of industrial requirements on the application level.

[News ID 1547](#)

### ■ **Softing: Profinet diagnostics with extended functionality**

Softing Industrial Automation announces the release of new versions for the proven PROFINET diagnostics solutions TH SCOPE and TH LINK. Additional functionalities for the display of network topologies and for the performance and use of reference measurements make commissioning more efficient and effective, and allow the permanent monitoring of Ethernet-based networks, in particular PROFINET.

[News ID 1787](#)

### ■ **Renesas: virtual platform and fast Linux porting for new ASIC**

Renesas has announced a collaboration with the consulting firm ASTC in which it developed a new ASIC for a consumer electronics customer and was able to provide a full board support package (secure boot, drivers and OS) before the silicon was available.

[News ID 1786](#)

### ■ **Trinamic: intuitive development kit for stepper motor**

TRINAMIC Motion Control announces immediate availability of the TMCM-1043-KIT development system. Designed for Trinamic's highly integrated, NEMA 17-compatible TMCM-1043 stepDancer stepper motor module, the new development kit offers designers an easy-to-use PC-based GUI that allows one-click modification of motor drive current, micro-stepping and other key parameters.

[News ID 1782](#)

### ■ **NI reshapes instrumentation with software-based, all-in-one device**

NI announced VirtualBench, an all-in-one instrument that integrates a mixed-signal oscilloscope, function generator, digital multimeter, programmable DC power supply and digital I/O. Users interact with VirtualBench through software applications that run on PCs or iPads. The device provides the most common functionality affordably and opens up new possibilities for how engineers can use benchtop instruments.

[News ID 1732](#)

### ■ **Rohde & Schwarz: BroadR-Reach interface verification with RTO oscilloscopes**

Rohde & Schwarz has expanded the application field of the R&S RTO oscilloscopes to include the testing of automotive Ethernet interfaces. In line with the OPEN Alliance test specification, the new R&S RTO-K24 compliance test software enables users to perform automated tests on BroadR Reach Ethernet interfaces.

[News ID 1751](#)

### ■ **Advantech: PC-based computing platform makes vending machines intelligent**

Advantech released a new solution with the Intel Reference Design for Intelligent Vending. Advantech delivers the Vending Machine Controller functionality to a PC-based computing platform with a Vending Machine IO board. PC based computing platform makes vending machines intelligent, allowing enhanced user experience with LCD and touchscreen interface, telemetry, proximity marketing, advertising and data analytics (real time promotion, pricing update, i.e.) using data coming from the cloud.

[News ID 1545](#)

### ■ **IAR Systems supports TI's EnergyTrace technology**

IAR Systems announces that early support for Texas Instruments new EnergyTrace technology is available in the world-leading development toolchain IAR Embedded Workbench for MSP430. By combining IAR Systems' excellent Power Debugging technology with Texas Instruments' EnergyTrace, developers are able to investigate and optimize power consumption and fully take advantage of the ultra-low-power capabilities of the MSP430 microcontrollers.

[News ID 1742](#)

### ■ **Embedded Office: simplified development of safety-critical applications with C167 controller**

Embedded Office has extended the range of its Cert-Kits and is now offering for  $\mu$ C/OS-II a component pre-certified on the 16-bit microcontroller C167 from Infineon, which supports manufacturers of safety-critical systems in the standard-compliant development according to DIN EN50128 SIL-4. The C167 is a proven microcontroller, which is used very frequently in industry. The C167 is typically used in the automotive sector, in medical engineering and in industry, for example in railway applications.

[News ID 1806](#)

### ■ **Kithara: software solution for 10 Gbit/s Ethernet industrial cameras.**

Kithara Software has successfully completed a software solution for 10 Gbit/s Ethernet indus-

trial cameras. The support of GigE Vision in real-time allows for deterministic image capturing with high data rates, especially for quality assurance and robotics. Based on the Kithara real-time Ethernet drivers for 10 Gbit/s network controllers, data captured by cameras with accordingly high transfer rates can be processed in real-time to meet high-precision and time-critical requirements.

[News ID 1725](#)

### ■ **SYSGO: integrated VectorCAST and PikeOS 3.4 enable out-of-the-box test solution**

Vector Software has partnered with SYSGO to offer the VectorCAST software test tool in an integration with the latest version of microkernel based real-time operating system PikeOS 3.4. Certified to the highest safety and security standards, this RTOS is used in safety-critical applications such as aircraft, rail, medical instruments, automotive and industrial automation to meet DO-178 B, ISO 26262 and IEC 61508 regulations.

[News ID 1721](#)

### ■ **Conrad to stock test tools for Fluke Connect free App-based cloud solution**

Conrad Business Supplies has announced that it is to stock the complete range of test tools from Fluke that are compatible with the company's new Fluke Connect free App-based cloud solution. The range extends for the launch to 20 tools and includes infrared cameras, digital multimeters, current, voltage and temperature measurement meters, vibration and insulation testers plus other process tools and accessories.

[News ID 1720](#)

### ■ **VadaTech: data processing board with a rear I/O interface**

VadaTech now offers a new data processor that meets the MicroTCA.4 specification with a rear I/O interface. The board is ideal for several High Energy Physics applications such as cavity field stabilization and standing-wave linear accelerators, as well as other systems requiring high speeds DSPs and low latency.

[News ID 1565](#)

### ■ **Wibu-Systems and Wincor Nixdorf join forces to increase security**

Wibu-Systems and Wincor Nixdorf expand their long-term collaboration and offer their respective expertise in the area of Digital Rights Management, IT services, and Service Desk solutions to the market. In times of industrial espionage, eavesdropping scandals, cyber-attacks and mysterious backdoors in routers and firewalls, endpoint encryption is crucial to protect business. Since 2009, Wincor Nixdorf uses CryptTA to ensure authorized access to test and diagnostic functions.

[News ID 1664](#)



■ **Telit adds LS Research to global roster of competence centers**

Telit Wireless Solutions has selected LS Research, a global leader in wireless product development, as its newest Competence Center. As part of its One Stop. One Shop. strategy, Telit Competence Centers play a critical role in offering M2M design, development and integration assistance to customers worldwide. The main objective of the Competence Center is to identify and execute designs for specific customer applications based on Telit technologies.

[News ID 1593](#)

■ **Digia updates Qt Enterprise Embedded**

Digia has released an update to Qt Enterprise Embedded, the fully-integrated solution that enables users to get started immediately with embedded device creation with a tailored user experience ready to address the Internet of Things connected device trend. Today's release includes the latest Qt 5.3 libraries, Qt WebEngine, Qt Quick Compiler, integration to the Qt Cloud and several other improvements

[News ID 1613](#)

■ **NI: LabVIEW software now fully compatible with Lego Mindstorms EV3**

National Instruments has added the capability to use NI LabVIEW system design software to program the LEGO MINDSTORMS EV3 system, the newest version of the popular LEGO MINDSTORMS robotics platform. The LabVIEW LEGOMINDSTORMS Module, a free download with LabVIEW and LabVIEW for LEGO MINDSTORMS, is available for education and retail. The software helps students, engineers and hobbyists alike create programs that communicate with and control the EV3 brick similar to the current way they use LabVIEW to extend the capabilities of NXT.

[News ID 1610](#)

■ **TI: FRAM MCU families with EnergyTrace++ real-time power profiler and debugger**

Texas Instruments announced its comprehensive ultra-low power FRAM microcontroller platform with all the necessary hardware and software tools, and support for developers to reduce energy budgets, minimize product size and enable a battery-free world. TI's new MSP430FR59x/69x FRAM MCU families with EnergyTrace++ real-time power profiler and debugger range from 32 to 128 KB embedded FRAM.

[News ID 1738](#)

■ **Rohde & Schwarz joins M2M Alliance**

Rohde & Schwarz is strengthening its commitment to machine to machine communications and the Internet of Things by joining the M2M Alliance. The reliability and security of mobile and wireless technologies are crucial

to the success and acceptance of M2M applications. There are many industries where wireless applications have not previously played a role, but now even household appliance manufacturers, for example, are facing the challenge of integrating wireless components into their products. They need to verify that these components function correctly and obtain any necessary certification.

[News ID 1574](#)

■ **Maxim: reference design enables more intelligent grid data management**

Utilities and infrastructure providers can now simultaneously and accurately measure distributed power grid data with Petaluma, a subsystem reference design from Maxim Integrated Products. Petaluma is a high-speed, simultaneous-sampling, 8-channel analog input front-end that monitors grid data simultaneously from all phases, so grid managers can optimize their distribution automation signal chain.

[News ID 1570](#)

■ **INSIDE Secure: software secure element for mobile applications**

INSIDE Secure announces the launch of MatrixSSE, a software secure element for mobile applications including enterprise, entertainment and financial applications. The solution allows mobile applications to securely process and store sensitive data in a hostile mobile environment. It simplifies the integration of security into mobile applications and allows them to defend against malicious attacks.

[News ID 1566](#)

■ **Vector Software opens new office in Italy**

Vector Software is opening a new office in Italy. The office is located in Milan, a location chosen to best serve key customers in key regions of Italy, as well as clients located in Switzerland and France. Over the past decade, the VectorCAST embedded testing solution has found a strong following in the automotive and aerospace sectors within Italy, and the Milan office will be a great asset in providing technical and sales support to these customers.

[News ID 1556](#)

■ **PEAK-System: Nohau is new distributor for Scandinavia**

PEAK-System, provider of hardware, software, and services related to the field buses CAN and LIN, supplements its worldwide distributor network by partnering with Nohau Solutions (Malmö, Sweden). The company is an established distributor for whole Scandinavia (Sweden, Denmark, Finland, Norway). Its philosophy with focus on developer support in the embedded market fits well to the product range of PEAK-System.

[News ID 1550](#)



**Editors**

Jürgen Hübner  
phone +49(0)8092-2477413  
fax +49(0)8092-2477429  
jh@iccmmedia.com

Wolfgang Patelay  
wp@iccmmedia.com

Tony Devereux  
devrex@teyboyz.freemove.co.uk

**For Reader Inquiries and Address Changes please contact:**  
info@iccmmedia.com

**Sales & Marketing Director**

Manfred Blumoser  
phone +49(0)8092-2477411  
fax +49(0)8092-2477429  
mb@iccmmedia.com

Claudia Mellein  
cm@iccmmedia.com

Christiane Lockner  
cl@iccmmedia.com

**Sales Office - UK and USA, Benelux, Scandinavia**

Blue Sky Communications  
Malcolm Cameron  
21 Cliffe Avenue  
Westbrook,  
Margate, Kent CT9 5DU, UK  
phone +44 (0)77 88-10 84 11  
fax +44 (0)80 82-8010 57  
mc@blue-sky-communications.com

**Sales Office - Asia**

Jean Cheng, jean@i-media.com.tw  
Vivian Hung, vivian@i-media.com.tw  
Innovative Media Information & Services  
7F-3, No. 26, Sec. 2, Ming-Quan East Rd.  
Taipei 104 Taiwan  
phone +886 2 2563 1186

**Head Office**



ICC Media GmbH  
Rauwagnerstr. 5  
85560 Ebersberg / Germany

**Editorial Office UK**

36a Blackacre Road  
Theydon Bois  
Essex, CM16 7LU

Copyright© All rights reserved.

No part of this publication may be reproduced or transmitted in any form or by any means without the prior express written permission of ICC Media. Although we make every effort to present up-to-date, accurate information, boards&solutions will not be responsible for any errors or omissions or for any results obtained from the use of such information. The magazine will not be liable for any loss caused by the reliance on information obtained on this site. Furthermore, boards&solutions does not warrant the accuracy or completeness of the information, text, graphics in this magazine. The opinions expressed in the articles are those of the authors and not necessarily the opinions of the publisher.

■ **Rutronik: reference design for Bluetooth Smart Beacons from Nordic Semi**

Rutronik offers the nRF51822 Bluetooth Smart Beacon Kit from Nordic Semiconductor. The reference design is based on Nordic's nRF51822 multiprotocol Bluetooth Smart and proprietary 2.4GHz-SoC. It allows demonstration and development of iBeacon and proprietary beacon hardware for iOS and Android smartphones to be developed quickly and easily.

[News ID 1544](#)

■ **ExpressLogic: eXtremeDB In-Memory DBMS pairs with ThreadX RTOS**

McObject and Express Logic announced a partnership in which eXtremeDB has been ported to ThreadX. The integration delivers a fast and cost-effective new platform for developing and deploying today's increasingly ubiquitous, data-intensive connected devices. Target applications of the eXtremeDB in-memory database system running on ThreadX include consumer electronics, medical devices, industrial controllers, sensor networks, communications gear and other embedded technology demanding high performance, a small hardware footprint, reliability, and a flexible development environment.

[News ID 1543](#)

■ **Mouser to stock AD9652 16-bit ADC evaluation board with 310MSPS**

Mouser Electronics is the first to stock the AD9652-310EBZ Dual 16-bit analog to digital converter Evaluation Board from Analog Devices. The AD9652 ADC captures data at 310MSPS, has a high speed pipelined architecture, and boasts the best noise and dynamic range performance in its class.

[News ID 1724](#)

■ **Microchip expands PIC32MX1/2 MCU series with larger Flash and RAM**

Microchip announces a new family of PIC32MX1/2 microcontrollers in 256/64 KB Flash/Ram configurations. These new MCUs are coupled with comprehensive software and tools from Microchip for designs in digital audio with Bluetooth, USB audio, graphics, touch sensing and general-purpose embedded control. The MCUs are an expansion to the popular PIC32MX1/2 series of low-cost small-footprint 32-bit microcontrollers.

[News ID 1746](#)

■ **ADI: digital isolator devices optimized for SPI communications applications**

Analog Devices introduced a new family of digital isolator devices optimized for serial peripheral interface communications systems. The ADuM315x SPI Isolator digital isolator family is based on ADI's iCoupler digital isolator technology, which has been shipped in volumes exceeding one billion channels.

[News ID 1736](#)

■ **Telit: click board offers easy prototyping with LE70-868 short range module**

Telit Wireless Solutions and MikroElektronika release tRF click, the 76th addition to MikroElektronika's line of click boards, small extension boards that offer easy hardware expandability and rapid prototyping for embedded developers. tRF click carries the LE70-868 short range module from Telit, along with an SMA connector for an antenna, two radio communication LEDs, and a mikroBUS connector.

[News ID 1735](#)

■ **Microchip: XLP low-power PIC MCUs with integrated hardware encryption engine**

Microchip announces the expansion of its eXtreme Low Power PIC microcontrollers with the PIC24F "GB2" family. This new family features an integrated hardware crypto engine, a Random Number Generator and One-Time-Programmable key storage for protecting data in embedded applications. The PIC24F "GB2" devices offer up to 128 KB Flash and 8 KB RAM in small 28- or 44-pin packages, for battery-operated or portable applications such as "Internet of Things" sensor nodes, access control systems and door locks.

[News ID 1733](#)

■ **Xilinx and Pico Computing announce 15Gb/s HMC interface**

Xilinx and Pico Computing announce the industry's first 15Gb/s Hybrid Memory Cube (HMC) interface for All Programmable UltraScale devices. The Xilinx UltraScale devices support the full HMC bandwidth of 4 lanes, comprised of 64 transceivers running up to 15Gb/s. Pico Computing's HMC controller IP yields exceptionally high memory bandwidth and outstanding performance/watt in a small but modular and highly scalable footprint.

[News ID 1726](#)

■ **Telit and IOTAS achieve first M2M product certification through GCF**

Telit Wireless Solutions and IOTAS, the UK's independent wireless field testing company, announced that following the introduction of a new class of membership for device makers integrating embedded wireless modules, the Global Certification Forum (GCF) has certified the first product to successfully achieve the new certification.

[News ID 1717](#)

■ **Microchip: 5 kOhm digital potentiometers with specified 36V operating voltage**

Microchip announces the expansion of its 36V digital potentiometer portfolio with two new volatile, I2C devices: the MCP45HV31 and MCP45HV51 (MCP45HV31-51). These are the industry's first digipots to offer a 5 kOhm resistance with a specified operating

voltage of 36V. In addition, they provide 10V to 36V analogue operation and 1.8V to 5.5V digital operation, for systems requiring wide signal swings or high power-supply voltages.

[News ID 1711](#)

■ **Freescale: sub 1 GHz wireless MCU uses energy-efficient 32-bit processor core**

Freescale Semiconductor is now shipping the Kinetis KW01 wireless microcontroller, expanding the popular Kinetis W series MCU line with a device suited for wirelessly networked smart object applications. The Kinetis KW01 MCU features the first ARM Cortex M0+ based universal sub-GHz radio to reach mass production. Several protocols are emerging globally for outdoor and indoor smart object networks that require robust communication and low power consumption.

[News ID 1680](#)

■ **TI expands portfolio of three-phase smart e-meter SoCs**

Texas Instruments announced new three-phase metering systems-on-chip for smart electricity meters and portable measurement applications. The new MSP430F67641 SoCs include high-performance delta-sigma ADCs for energy measurement products requiring high accuracy across a wide dynamic range.

[News ID 1667](#)

■ **GE: rugged 6U VPX single board computer**

GE Intelligent Platforms announced the SBC626 rugged 6U VPX single board computer featuring latest quad-core 4th generation Intel Core i7 processor. The SBC626 is the fourth product featuring Intel's latest processor to be announced by GE Intelligent Platforms. The range now includes 3U and 6U platforms featuring VME as well as VPX.

[News ID 1718](#)

	COMPANY	PAGE
Advertisers Index	abe	28
	ADLINK	7
	Avalue	17
	Digi-Key	2
	Elma Electronic	22
	Green Hills Software	5
	Messe München	52
	MSC Technologies	3
	PEAK	9
	Trinamic	19

■ **Infinion: sensor with two vertical Hall plates measures rotation speed and direction**

In the future, power window lift and power trunk lift system design will be completely transformed; other automotive applications with space restrictions, such as sun roofs and seat adjustment, will also benefit. Infineon makes this possible with its TLE4966V, a vertical dual-Hall sensor.

[News ID 1652](#)

■ **Microchip: new family of USB power delivery controllers**

Microchip announces a new family of USB Power Delivery controllers - the UPD100X with an industry-standard power delivery and battery charging protocol. A single USB cable can be used for data and simultaneously deliver up to 100W of power from a single standard USB port which is 40 times the power compared to USB 2.0. With up to 100W of available power, designers can dynamically allocate this power to fast battery charging and system power.

[News ID 1647](#)

■ **Swissbit: CompactFlash card with long-term availability through to at least 2021**

Swissbit presents the C-300 Longevity, the first CompactFlash card with long-term availability through to at least 2021. Its feature set, which includes an optimised random write speed and backward compatibility, makes the C-300 Longevity the ideal choice for highly-demanding applications in the telecommunications and networking market, as well as applications requiring maximum longevity due to time-consuming and cost-intensive re-qualification processes.

[News ID 1642](#)

■ **ATP: wide temperature DRAM modules target industrial applications**

ATP introduces a new DRAM module product line for operating under -40 to 85°C wide temperature conditions. This new solution targets industrial applications such as telecom, networking, IPC, automation and ruggedized systems, and achieve the best total cost ownership with long term system reliability. Available immediately in DDR3 SODIMMs, mini-DIMMs, and VLP DIMMs, in densities from 4 to 8GB.

[News ID 1639](#)

■ **Cadence: production proven USB 3.0 host controller IP**

Cadence Design Systems announces that a production proven host controller intellectual property for USB 3.0 has been added to the Cadence IP offering. The Cadence USB 3.0 xHCI host controller IP was originally developed by Fresco Logic. This design IP is used as part of a recommended Peripheral Development Kit (PDK) for compliance testing by the USB-IF and has been deployed in over a billion USB ports.

[News ID 1635](#)

■ **RECOM warns against counterfeit**

Currently, the market is flooded with cheap copies of electronic components from Asia. Among them are an increasing number of instances of counterfeits of the RECOM brand. Frequently, the original images are shown on the internet, but in reality both part number designation and logo are fakes. RECOM is working hard to track down the illegal providers and take legal action against pirates. For RECOM it is important to protect its customers against inferior fakes.

[News ID 1620](#)

■ **Hyperstone: industrial USB Flash memory controller**

Hyperstone introduces their new U8 industrial USB Flash memory controller. U8 is targeting industrial applications such as removable USB Flash drives and embedded USB Flash modules. Together with Hyperstone's proprietary hyReliability firmware, it provides enhanced endurance and data retention management, as well as rigorous fail-safe features, all of which are mandatory for industrial applications.

[News ID 1619](#)

■ **TI: fastest Hercules MCUs target functional safety applications**

Texas Instruments introduces its latest 32-bit dual-core lockstep Hercules RM57Lx and TMS570LCx microcontrollers for developers' functional safety applications. Unique to the Hercules MCU platform, these two new floating-point devices offer a 50 percent increase in computational performance over any of TI's current ARM Cortex-R MCUs, allowing system designers to utilize a single Hercules MCU to replace several discrete MCUs or an FPGA-MCU combination.

[News ID 1609](#)

■ **Silicon Labs eases smart meter design with wireless M-bus software**

Silicon Labs introduces a comprehensive software solution designed to simplify the development of wirelessly connected smart meters for electricity, gas, water and heat resources based on the proven Wireless M-Bus standard. Silicon Labs' Wireless M-Bus software complements the company's microcontroller and wireless IC products and development kits for the rapidly growing smart metering and smart grid markets.

[News ID 1601](#)

■ **Cadence and ARM expand collaboration for 64-bit processor designs**

Cadence announces the signing of the first EDA (Electronic Design Automation) Technology Access Agreement with ARM that includes access to the ARM Cortex-A50 processor series, based on the ARMv8-A 64-bit architecture. This agreement also provides access to ARMv7 32-bit processor technology, ARM Mali GPUs, System IP and ARM Artisan libraries.

[News ID 1599](#)

■ **Infinion: new leadless SMD package for CoolMOS MOSFETs**

Infinion introduces a new leadless surface mounted package for CoolMOS MOSFETs named ThinPAK 5x6. For chargers, there is a clear trend towards smaller, faster and more efficient solutions. With its height of only 1mm and with its very small footprint of 5 x 6 mm the ThinPAK 5x6 provides 80 percent volume reduction in comparison to traditional SMD packages such as DPAK. Thus, manufacturers gain flexibility for the design of even smaller chargers.

[News ID 1582](#)

■ **Rutronik: 24nm 8Gb BENAND SLC NAND Flash memory from Toshiba**

Toshiba presents the new 8Gb 24nm BENAND SLC (single level cell) NAND flash memory with embedded 8bit error correction. It enables manufacturers to utilize the latest 24nm technology in devices designed to use 4xnm NAND, extending the product life of consumer electronics, multimedia devices, smart meters, intelligent lighting systems and industrial technology. The new NAND flash memory is available at distributor Rutronik as of now.

[News ID 1580](#)



**boards & solutions + ECE**

A digital library to the Internet of Things



**FREE SUBSCRIPTION to Boards & Solutions / ECE Magazine**

**The European Embedded Systems Design Magazine**

Technical Articles and Product News about:

- Embedded Computing (Boards, Modules, Systems, Software, Services)
- Chip-level Hardware (Microcontrollers, ASSPs, Analog & Power Management, FPGAs)
- Tools & Software

[www.embedded-control-europe.com/magazine](http://www.embedded-control-europe.com/magazine)







Messe München  
International

Connecting Global Competence

# Welcome to Planet e.

The entire embedded universe at a single location!

Tickets & Registration  
[www.electronica.de/en/tickets](http://www.electronica.de/en/tickets)

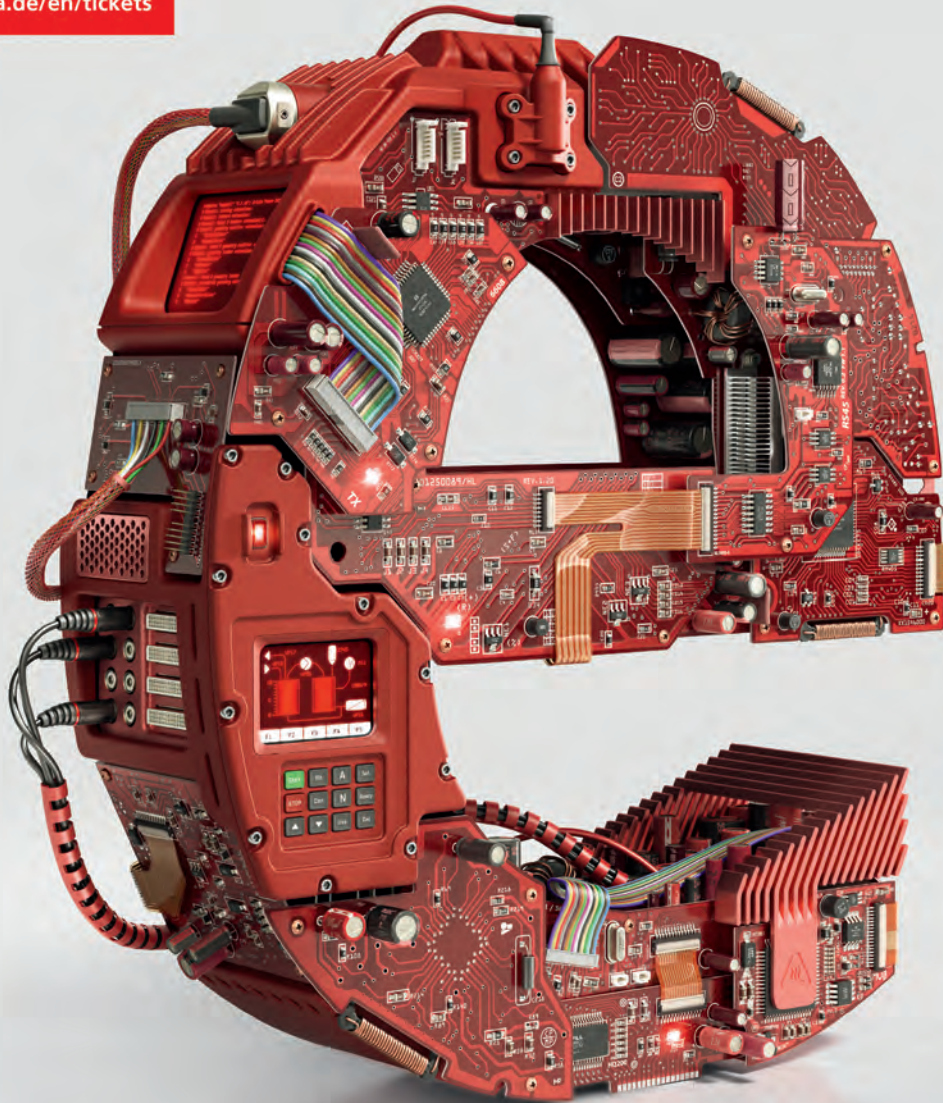

26th International Trade Fair for  
Electronic Components, Systems  
and Applications  
Messe München  
November 11–14, 2014  
[www.electronica.de](http://www.electronica.de)

50 years  
electronica



**electronica** 2014  
inside tomorrow